



Radian Series Inverter/Charger

GS4048A

GS8048A



Installation Manual





About OutBack Power Technologies

OutBack Power Technologies is a leader in advanced energy conversion technology. OutBack products include true sine wave inverter/chargers, maximum power point tracking charge controllers, and system communication components, as well as circuit breakers, batteries, accessories, and assembled systems.

Applicability

These instructions apply to OutBack inverter/charger models GS8048A and GS4048A only.

Contact Information

Address:	Corporate Headquarters 17825 – 59 th Avenue N.E. Suite B Arlington, WA 98223 USA	European Office Hansastraße 8 D-91126 Schwabach, Germany
Website:	http://www.outbackpower.com	

Disclaimer

UNLESS SPECIFICALLY AGREED TO IN WRITING, OUTBACK POWER TECHNOLOGIES:

(a) MAKES NO WARRANTY AS TO THE ACCURACY, SUFFICIENCY OR SUITABILITY OF ANY TECHNICAL OR OTHER INFORMATION PROVIDED IN ITS MANUALS OR OTHER DOCUMENTATION.

(b) ASSUMES NO RESPONSIBILITY OR LIABILITY FOR LOSS OR DAMAGE, WHETHER DIRECT, INDIRECT, CONSEQUENTIAL OR INCIDENTAL, WHICH MIGHT ARISE OUT OF THE USE OF SUCH INFORMATION. THE USE OF ANY SUCH INFORMATION WILL BE ENTIRELY AT THE USER'S RISK.

OutBack Power Technologies cannot be responsible for system failure, damages, or injury resulting from improper installation of their products.

Information included in this manual is subject to change without notice.

Notice of Copyright

Radian Series Inverter/Charger Installation Manual © 2017 by OutBack Power Technologies.
All Rights Reserved.

Trademarks

OutBack Power, the OutBack Power logo, and Grid/Hybrid are trademarks owned and used by OutBack Power Technologies, Inc. The ALPHA logo and the phrase “member of the Alpha Group” are trademarks owned and used by Alpha Technologies Inc. These trademarks may be registered in the United States and other countries.

Date and Revision

September 2017, Revision B

Part Number

900-0160-01-01 Rev B



Table of Contents

Introduction	5
Audience	5
Symbols Used	5
General Safety	5
Welcome to OutBack Power Technologies	6
Components and Accessories	7
Planning	9
Applications	9
Input Modes	10
Renewable Energy	11
Battery Bank	11
Generator	14
Generator Sizing	14
Maintenance Bypass Switching	14
Installation	17
Location and Environmental Requirements	17
Dimensions	17
Tools Required	19
Mounting	19
Component Mounting	21
Removing Front Cover	22
Terminals and Ports	23
Wiring	25
Grounding	25
DC Wiring	26
AC Wiring	29
ON and OFF Wiring	32
Accessory Wiring	33
AUX Wiring	33
Generator Control	35
AC Configurations	38
Single-Inverter	38
Multiple-Inverter AC Installations (Stacking)	40
Stacking Configurations	43
Commissioning	49
Pre-startup Procedures	49
Startup	49
Powering Down	51
Adding New Devices	51
Operation	52
Firmware Updates	52
.GIP File Installation for Grid Support	53
Preventative Maintenance	54
Definitions	55
Index	57

List of Tables

Table 1	Components and Accessories	7
Table 2	Battery Bank Elements.....	12
Table 3	Ground Conductor Size and Torque Requirements.....	25
Table 4	DC Conductor Size and Torque Requirements.....	27
Table 5	Changing Master Power Save Levels (GS8048A).....	48
Table 6	Terms and Definitions.....	55

List of Figures

Figure 1	Radian Series Inverter/Charger.....	6
Figure 2	Radian Inverter and Accessories	7
Figure 3	Applications (Example)	9
Figure 4	Bypass Switching	15
Figure 5	Bypass Switching for Multiple Inverters.....	15
Figure 6	Dimensions	17
Figure 7	System Dimensions	18
Figure 8	Installing the Mounting Plate	19
Figure 9	Mounting the Inverter	20
Figure 10	Mounting for System Components.....	21
Figure 11	Removing the Front Cover	22
Figure 12	DC Terminals, Ribbon Cables, and Auxiliary Terminals	23
Figure 13	AC Terminals, Ports, and Ground Bus.....	24
Figure 14	Chassis Ground TBB	25
Figure 15	GS8048A and GS4048A Battery Terminals.....	27
Figure 16	DC Cable Hardware (Radian inverter)	28
Figure 17	AC Terminals	29
Figure 18	AC Sources	31
Figure 19	ON/OFF Jumper and Connections.....	32
Figure 20	Accessory Connections.....	33
Figure 21	AUX Connections for Vent Fan (Example).....	34
Figure 22	AUX Connections for Diversion (Example)	34
Figure 23	Two-Wire Generator Start (Relay Aux)	35
Figure 24	Two-Wire Generator Start (12V AUX).....	36
Figure 25	Three-Wire Generator Start (Example).....	37
Figure 26	Single-Inverter AC System.....	38
Figure 27	Single-Inverter AC Wiring with GS Load Center	39
Figure 28	OutBack Communications Manager and System Display.....	40
Figure 29	Example of Parallel Stacking Arrangement (Three Inverters).....	43
Figure 30	Parallel Wiring	44
Figure 31	Parallel Wiring with GSLC.....	45
Figure 32	Power Save Levels and Loads.....	46
Figure 33	GS8048A Power Save Priority	47
Figure 34	AC Test Points	50
Figure 35	Grid Support Screens.....	53







Introduction

Audience

This book provides instructions for the physical installation and wiring of this product. These instructions are for use by qualified personnel who meet all local and governmental code requirements for licensing and training for the installation of electrical power systems with AC and DC voltage up to 600 volts. This product is only serviceable by qualified personnel.

Symbols Used



	WARNING: Hazard to Human Life This type of notation indicates that the hazard could be harmful to human life.
	CAUTION: Hazard to Equipment This type of notation indicates that the hazard may cause damage to the equipment.
	IMPORTANT: This type of notation indicates that the information provided is important to the installation, operation and/or maintenance of the equipment. Failure to follow the recommendations in such a notation could result in voiding the equipment warranty.
	NOTE: This type of notation indicates useful information. This symbol is not always used.



MORE INFORMATION

When this symbol appears next to text, it means that more information is available in other manuals relating to the subject. The most common reference is to the *Radian Series Inverter/Charger Operator's Manual*. Another common reference is the system display manual.

General Safety

	WARNING: Limitations on Use This equipment is NOT intended for use with life support equipment or other medical equipment or devices.
	WARNING: Reduced Protection If this product is used in a manner not specified by GS product literature, the product's internal safety protection may be impaired.
	CAUTION: Equipment Damage Only use components or accessories recommended or sold by OutBack Power Technologies or its authorized agents.

Welcome to OutBack Power Technologies

Thank you for purchasing the OutBack Radian Series Inverter/Charger. This product offers a complete power conversion system between batteries and AC power. It can provide backup power, sell power back to the utility grid, or provide complete stand-alone off-grid service.

- Designed to be integrated as part of an OutBack Grid/Hybrid™ system
- Battery-to-AC inverting which delivers split-phase power (100/200 Vac to 120/240 Vac at 60 or 50 Hz)
- Model GS8048A can continuously produce 8 kVA (33 Aac)
Model GS4048A can continuously produce 4 kVA (16 Aac)
- Mounts easily with supplied mounting plate
- All terminals exit at the bottom of the inverter, allowing the installer to use a single distribution box; the GS Load Center (GSLC) is specifically designed for this purpose
- Uses the MATE3™ class of System Display and Controller products, or the AXS Port™ SunSpec Modbus Interface (sold separately) for user interface as part of a Grid/Hybrid system
 - ~ MATE3s system display is required for grid support functionality; requires revision 1.001.000 or greater
- Supports the OPTICS RE™ online tool¹ for a cloud-based remote monitoring and control application
 - ~ Requires MATE3-class device or AXS Port
 - ~ Visit **www.outbackpower.com** to download
- Uses the HUB™ Series Communications Manager for networking as part of a Grid/Hybrid system
- Features versatile mounting locations for the MATE3 and HUB products, FLEXmax charge controller, and GSLC
- The venting on the cover allows mounting of multiple Radian inverters side by side with minimal clearance between them
- Up to 10 Radian inverter/chargers can be stacked together
- Uses spring-based AC terminals instead of screw-based terminals; this eliminates torque requirements and periodic re-tightening
- Listed by ETL to UL 1741 (2nd Edition with supplement SA) and CSA 22.2



Figure 1 Radian Series Inverter/Charger



NOTE:

This product has a settable AC output range. In this book, many references to the output refer to the entire range. However, some references are made to 120/240 Vac or 60 Hz output. These are intended as examples only.

¹Outback Power Technologies Intuitive Control System for Renewable Energy

Components and Accessories



	<p>IMPORTANT:</p> <ul style="list-style-type: none"> ❖ The Radian inverter is compatible with the MATE3 class of system display products. It can be used with any firmware revision of MATE3s. It can only be used with MATE3 revision 002.017.000 or higher. ❖ The MATE3s system display must be used when upgrading the inverter to firmware revision 001.006.063 or higher. ❖ The Radian inverter is not intended for use with the OutBack MATE or MATE2 products. Use of these products is not supported with the Radian Series.
	<p>IMPORTANT:</p> <p>This product is not stackable with the GS8048 inverter. See page 39.</p>

Table 1 Components and Accessories

Included in Box	
<i>Radian Series Inverter/Charger Quick Start Guide</i>	Mounting Bracket
RTS (Remote Temperature Sensor)	Hardware Kit
Optional Components for Attachment to Radian Inverter	
MATE3-class System Display and Controller	FLEXmax Series Charge Controller
GSLC (GS Load Center) series	HUB Series Communications Manager



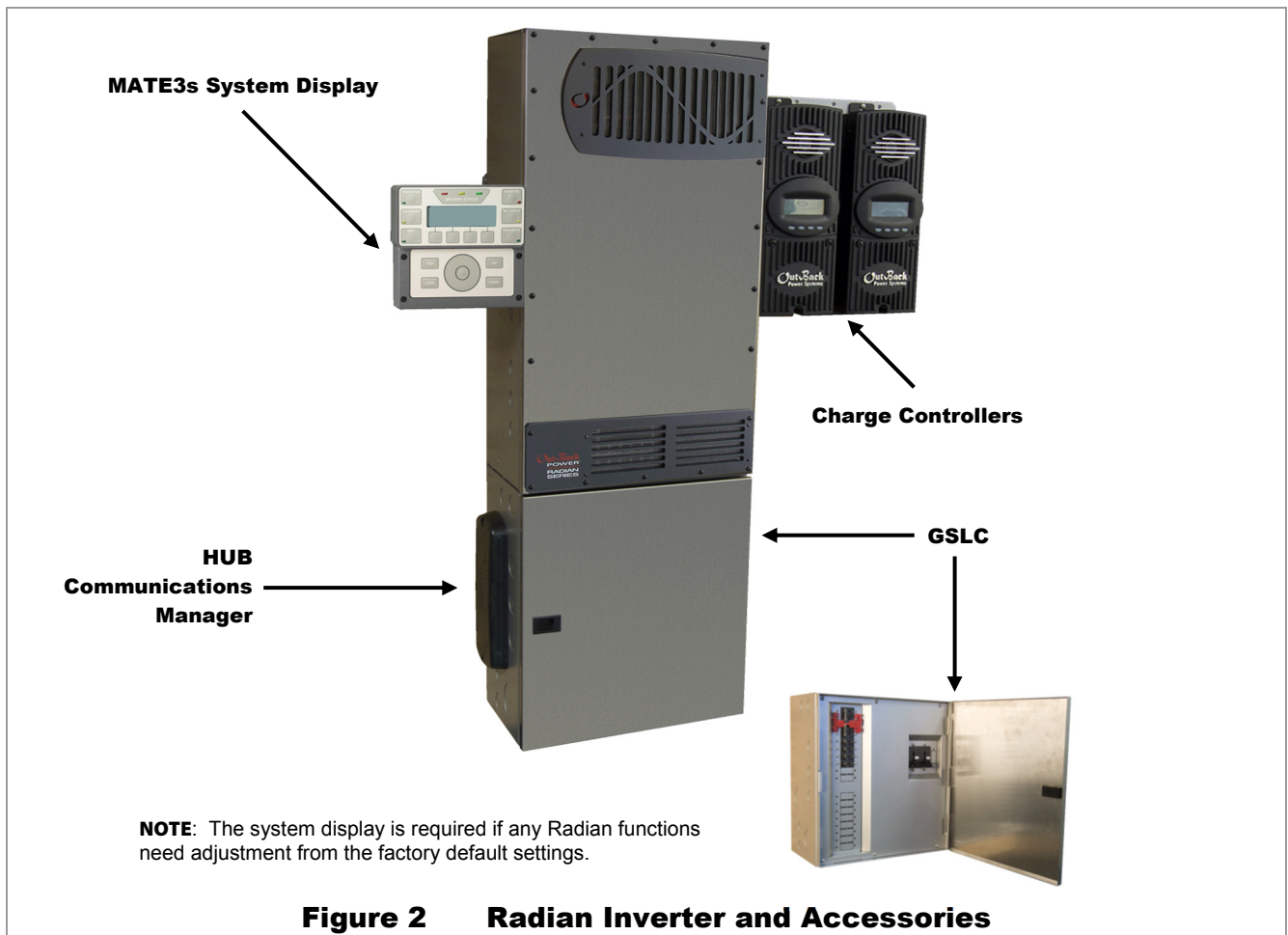

Planning

Applications

OutBack inverterchargers are designed to use a battery bank to store energy. They work together with power from the utility grid or from renewable energy sources, such as photovoltaic (PV) modules, wind turbines, and other renewable sources. These sources charge the battery, which is used by the inverter.

The Radian inverter has two sets of AC input terminals. Two AC sources, such as a gas or diesel generator and the utility grid, can be connected. Other combinations of AC sources are possible.

NOTE: The inverter can only accept one source at a time. The input marked **GRID** has priority, although this can be changed.

The Radian inverter's settings can be changed to accommodate many applications. These include off-grid, backup, and grid-interactive applications. 

This product includes grid support functionality according to UL1741 SA. See the *Operator's Manual* for more information. Contact the utility company for any specific installation requirements.

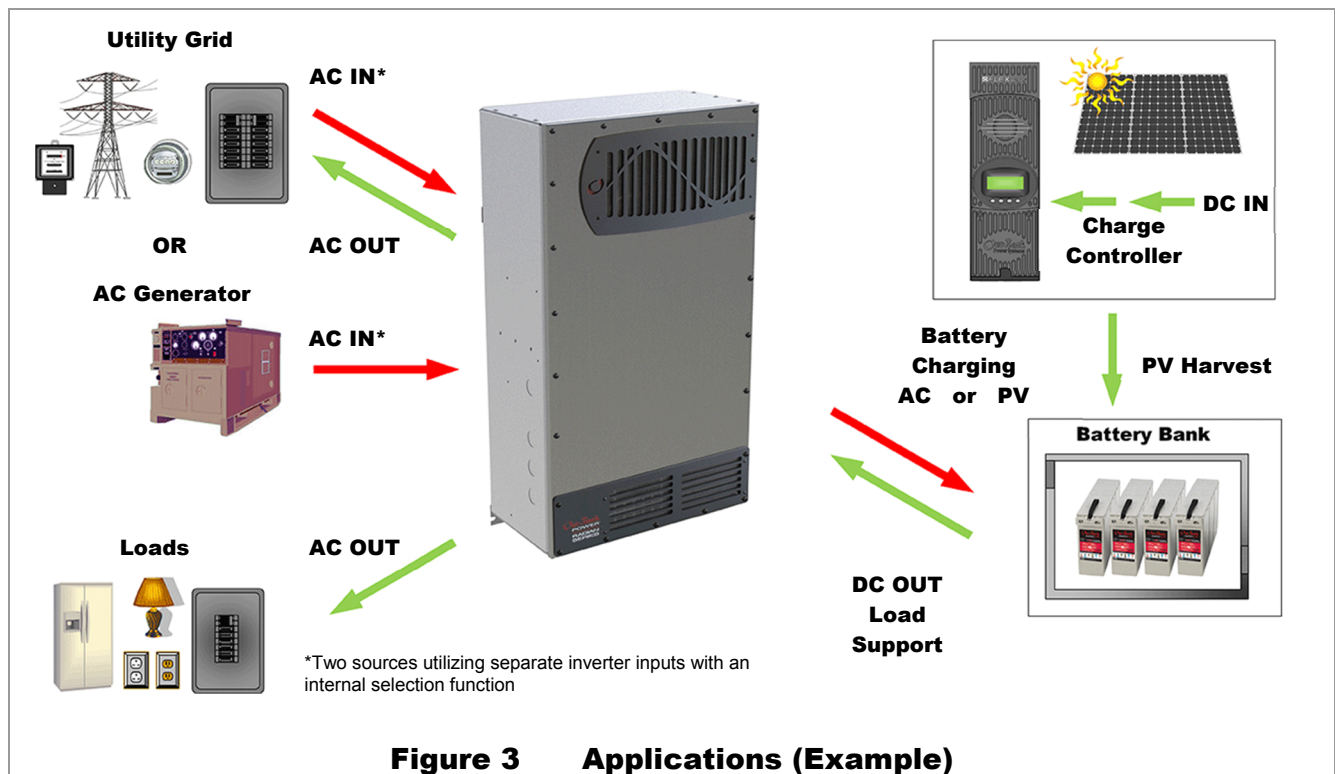

Input Modes

The Radian inverter has many modes of operation. See the *Radian Series Inverter/Charger Operator's Manual* for additional information on these modes, including reasons and considerations for using each mode.

The modes determine how the inverter interacts with an AC source. Each mode has functions and priorities that are intended for a designated application. Each of the Radian's two AC inputs can be set to a different operating mode to support different applications.

- **Generator:** This mode enables the battery charging function to tolerate a wider range of generator performance and waveform irregularities than other modes. The Radian can use generator power even when the generator is substandard.
- **Support:** This mode is intended for systems using utility grid or a generator. In some cases the amount of current available from the source is limited due to size, wiring, or other reasons. If large loads need to be run, the Radian inverter augments (supports) the AC source. The inverter uses battery power and additional sources to ensure that the loads receive the power they demand.
- **Grid Tied:** This mode is intended for grid-interactive systems that are net metered. Once the battery is charged and protected loads are served, the inverter will export power to the utility grid. Grid support functionality is available in this mode.
- **UPS:** This mode is intended for systems primarily intended to maintain power to the loads without any interruption when switching between AC input and batteries. The response speed has been increased so that if an AC disconnect occurs the response time will be minimized.
- **Backup:** This mode is intended for systems that have the utility grid or a generator available, but do not have specialty requirements such as selling or support. The AC source will flow through the Radian inverter to power the loads unless power is lost. If power is lost, then the Radian inverter will supply energy to the loads from the battery bank until the AC source returns.
- **Mini Grid:** This mode is intended for systems that have the utility grid as an input and a sizable amount of renewable energy. It behaves like an off-grid system using the utility grid as a backup generator. The system will use the renewable energy until the battery voltage falls to a specified low level. When this occurs, the Radian inverter will connect to the utility grid to power the loads. The inverter will disconnect from the utility grid when the batteries are sufficiently recharged.
- **GridZero:** This mode is intended for systems that have the utility grid as an input and a sizable amount of renewable energy. The loads will remain connected to the utility grid, but will only draw power from it when no other power is available. The default power sources are the batteries and renewable energy, which attempt to "zero" the use of the AC source. This mode does not allow the inverter to charge batteries or sell. The batteries are discharged and recharged while remaining grid-connected. Grid support functionality is available in this mode.

See the *Radian Series Inverter/Charger Operator's Manual* for additional information on these modes, including the reasons and considerations for using each mode.

Programming

Selection of the input modes and all other inverter programming are performed using a system display such as the MATE3s. This product can customize a wide range of parameters. 

Renewable Energy

The Radian inverter cannot connect directly to PV, wind turbines, or other unregulated DC sources. The batteries are the inverter’s primary source of power.

A renewable energy source is always treated as a battery charger, even if all of its power is used immediately by the inverter. The renewable source must have a charge controller, or some other regulation method, to prevent overcharging. OutBack Power’s FLEXmax family of charge controllers can be used for this purpose, as can other products.



The GSLC will receive the mechanical and electrical connections for up to two FLEXmax charge controllers. It can receive the electrical connections for two FLEXmax 100 controllers.

Battery Bank

When planning a battery bank, consider the following:

- **Cables:** Recommendations for battery cable size and length are shown on page 26. The maximum length will determine the placement of the battery bank. Local codes or regulations may apply and may take priority over OutBack recommendations.
- **Battery Type:** The Radian inverter/charger uses a three-stage charge cycle.
 - ~ The default inverter/charger settings assume a deep-cycle stationary lead-acid battery, such as OutBack’s EnergyCell RE or NC series batteries. The charging configuration is highly customizable so that lithium-ion and other advanced chemistry charging cycles can be accommodated. Consult the documentation for the specific batteries used in the system to ensure that the settings are appropriate. 
 - ~ The Radian inverter/charger is designed to work with a 48-volt battery bank. Before constructing a battery bank, confirm the nominal voltage of individual batteries.
- **Charger Settings and Maintenance:** A vented battery enclosure may be required by electric code and is usually recommended for safety reasons. It may be necessary to use a fan to ventilate the battery enclosure.

Batteries must be regularly maintained according to the instructions of the battery manufacturer.

	<p>IMPORTANT:</p> <p>Battery charger settings need to be correct for a given battery type. Always follow battery manufacturer recommendations. Making incorrect settings, or leaving them at factory default settings, may cause the batteries to be undercharged or overcharged.</p>
	<p>CAUTION: Hazard to Equipment</p> <p>Batteries can emit vapors which are flammable and which are corrosive over long periods of time. Installing the inverter in the battery compartment may cause corrosion which is not covered by the product warranty. (Sealed batteries may be an exception.)</p>

Planning

- **Bank Size:** Battery bank capacity is measured in amp-hours. Determine the required bank specifications as accurately as possible, beginning with the items below. This avoids underperformance or wasted capacity.

These ten items are obtainable in different places, summarized in Table 2. Some of the information is specific to the site or application. Some can be obtained from the battery manufacturer. Information on OutBack products is available from OutBack Power Technologies or its dealers.

- A.** Size of load:
 - B.** Daily hours of use:
 - C.** Days of autonomy:
- } These are the most basic and essential factors used to determine bank size.
- D.** Application: This often helps define or prioritize the previous three items. Off-grid systems often require enough capacity to last for an extended period before recharging. Grid-connected systems frequently need only enough capacity for short-term backup during outages.
 - E.** Conductor efficiency: Wire size and other factors will waste power due to resistance and voltage drop. Typical acceptable efficiency is 96 to 99%.
 - F.** Inverter efficiency: Radian specifications list “Typical Efficiency” to help estimate operating loss.
- } Any losses are essentially amp-hour capacity that the system cannot use. The battery bank size can be increased to account for losses.
- G.** System DC voltage: The Radian inverter requires nominal 48 Vdc to operate.

Table 2
Battery Bank Elements

- H.** Battery voltage: Most individual battery voltages are less than the system DC voltage. The batteries need to be placed in series to deliver the correct voltage.
- I.** Capacity: Battery capacity, which is measured in ampere-hours (amp-hours or Ah), is not usually a fixed number. It is specified based on the rate of discharge. For example, the OutBack EnergyCell 200RE is rated at 128.4 Ah when discharged at the 4-hour rate (to terminal voltage 1.85 volts per cell or Vpc). This is a high rate of discharge that would hypothetically drain the battery in 4 hours. The same battery is rated at 170 Ah when used at the 20-hour rate.

Item	Source of information
A. Load Size	Site-specific
B. Daily Hours	Site-specific
C. Days of Autonomy	Site-specific
D. Application	Site-specific
E. Conductor Efficiency	Site-specific
F. Inverter Efficiency	Inverter manufacturer
G. System Vdc	Inverter manufacturer
H. Battery Vdc	Battery manufacturer
I. Capacity Ah	Battery manufacturer

Example:

Model	Discharge in Hours					
	1	2	3	4	8	20
200RE	82.0	120.0	119.1	128.4	148.8	170.0
220GH	127.3	151.4	162.9	169.6	190.8	206.0

- J.** Maximum DoD Battery manufacturer

In general, use the 8-hour capacity or less. The larger the load, the more severe the discharge. In these cases conservative values with faster discharge times from the table (for example, the 2- or 3-hour capacity) are better.

To choose accurately, the best method is to divide each Ah figure by the discharge in hours. (An example from Table 2 for the OutBack 200RE would be $119.1 \div 3 \text{ hours} = 39.7 \text{ Adc.}$) If the number is equal or greater than the load size (in DC amperes), that column can be used as the capacity.

NOTES:

- ~ The battery’s selected rated capacity may have little to do with the actual hours of use; this figure simply reflects the rate of discharge.
- ~ Use battery specifications for terminal voltage 1.85 Vpc whenever possible.
- ~ Capacity ratings are for batteries at 25°C. Capacity is reduced at cooler temperatures.

- J.** Maximum depth of discharge (DoD): Most batteries cannot be discharged below a certain level without damage. The bank requires enough total capacity to keep this from happening. DoD is usually described as a percentage, although it is shown as a decimal in calculations.

To Calculate Minimum Battery Bank Size (refer to previous page for letter designations):

1. The load size, item **A**, is measured in watts. Compensate this figure for efficiency loss. Multiply the conductor efficiency by the inverter efficiency (**E** x **F**). (These items are represented as percentages, but may be displayed as decimals for calculation.) Divide item **A** by the result.
2. Convert the compensated load into amperes (Adc). Divide the step **1** result by the system voltage (**G**).
3. Determine the best battery capacity (**I**) by dividing each rated capacity by the time in hours (as shown in Table 2). This is the estimated discharge rate at that battery capacity. The number is usable if the step **2** result (the actual load rate) does not exceed it. Choose the closest (or smaller) rated amp-hour capacity.
4. Determine the daily load consumption in ampere-hours (Ah). Multiply the step **2** result by the daily usage hours (item **B**).
5. Adjust the total for required days of autonomy (the days the system must operate without recharging) and the maximum DoD. Multiply the step **4** result by **C** and divide by **J**.

The result is the total amp-hour capacity required for the battery bank.

6. Determine the number of parallel battery strings required. Divide the Ah figure from step **5** by the individual battery capacity (**I**) determined in step **3**. Round the result to the next highest whole number.
7. Determine the total number of batteries required. Divide the system voltage by the battery voltage (**G** ÷ **H**). Multiply the result by the step **6** result.

The result is the total required quantity of the chosen battery model.

EXAMPLE #1

A. Backup loads: 1.0 kW (1000 W)	1. $A \div [E \times F]$	$1000 \div (0.98 \times 0.93) = 1097.2 \text{ W}$
B. Hours of use: 8	2. $1 \div G$	$1097.2 \div 48 = 22.9 \text{ Adc}$
C. Days of autonomy: 1	3. $I = \text{Ah} \div \text{hours}$	$184.8 \div 8 = 23.1 \text{ Adc}$ (larger than 22.9;
D. Grid-interactive system (GS4048A inverter)	Compare to 2	this means 184.8 Ah is acceptable)
E. Conductor efficiency: 98% (0.98)	4. $2 \times B$	$22.9 \times 8 = 182.9 \text{ Ah}$
F. Inverter efficiency: 93% (0.93)	5. $[4 \times C] \div J$	$[182.9 \times 1] \div 0.8 = 228.6 \text{ Ah}$
G. System voltage: 48 Vdc	6. $5 \div I$	$228.6 \div 184.8 = 1.24$ (rounded to 2)
H. Batteries: OutBack EnergyCell 220GH (12 Vdc)	7. $[G \div H] \times 6$	$[48 \div 12] \times 2 \text{ strings} = 8 \text{ batteries}$
I. Capacity determined at 8-hour rate: 184.8 Ah		
J. Maximum DoD: 80% (0.8)		

EXAMPLE #2

A. Backup loads: 1.65 kW (1650 W)	1. $A \div [E \times F]$	$1650 \div (0.97 \times 0.93) = 1829.1 \text{ W}$
B. Hours of use: 8	2. $1 \div G$	$1829.1 \div 48 = 38.1 \text{ Adc}$
C. Days of autonomy: 2	3. $I = \text{Ah} \div \text{hours}$	$119.1 \div 3 = 39.7 \text{ Adc}$ (larger than 38.1;
D. Off-grid system (GS4048A inverter)	Compare to 2	this means 119.1 Ah is acceptable)
E. Conductor efficiency: 97% (0.97)	4. $2 \times B$	$38.1 \times 8 = 304.8 \text{ Ah}$
F. Inverter efficiency: 93% (0.93)	5. $[4 \times C] \div J$	$[304.8 \times 2] \div 0.5 = 1219.4 \text{ Ah}$
G. System voltage: 48 Vdc	6. $5 \div I$	$1219.4 \div 119.1 = 10.2$ (rounded to 11)
H. Batteries: OutBack EnergyCell 200RE (12 Vdc)	7. $[G \div H] \times 6$	$[48 \div 12] \times 11 \text{ strings} = 44 \text{ batteries}$
I. Capacity determined at 3-hour rate: 119.1 Ah		
J. Maximum DoD: 50% (0.5)		

Generator

These Radian models can work with any “split-phase” generator that delivers reliable AC power at the appropriate system voltage and frequency. They cannot work with a single-phase or three-phase generator.



CAUTION: Equipment Damage

Use of a three-phase generator with this equipment may damage either the inverter or the generator. This damage to the inverter is not covered by the product warranty.

- The inverter/charger can provide a start signal to control an automatic start generator. If automatic generator starting is required, the generator must be an electric-start model with automatic choke. It should have two-wire start capability. For other configurations, additional equipment may be required.
- In any configuration, the inverter may need to be specifically programmed with the system display.  Perform all programming according to the specifications of the generator and the required operation of the inverter. Parameters to be programmed may include generator size, automatic starting requirements, and potential fluctuations in generator AC voltage.
- A generator that is to be installed in a building usually should not have a bond between the neutral and ground connections. The generator should only be bonded if there is a specific need. Installations in North America are expected to bond the neutral and ground at the main electrical panel. See page 29 for more information on neutral-ground bonding.

Generator Sizing

A generator should be sized to provide enough power for all expected use.

- A conservative estimate assumes that both the loads and charging will be maximized at the same time. However, this can result in an oversized generator with inefficient operation.
- A smaller generator may be used for average loads with the inverter’s Support mode providing support from the batteries during peak loads. The loads can be manually disconnected while charging.
- In general, the generator should be sufficiently powerful to handle all necessary load surges.

Other considerations:

- Available generator power may be limited by ratings for circuit breakers and/or generator connectors. The maximum allowed AC circuit breaker size is 50 Aac per Radian inverter/charger.
- Many generators may not be able to maintain AC voltage or frequency for long periods of time if they are loaded more than 80% of rated capacity. This statement may not apply to inverter-based generators, which typically have more stable voltage and frequency regulation.

Maintenance Bypass Switching

Inverter systems are often equipped with AC maintenance bypass switches or interlocks. If the inverter system ever needs to be shut down or removed, the AC sources and loads must be disconnected. A bypass device allows the AC source to deliver power directly to the loads, bypassing the inverter as shown in Figure 4. This can minimize disruption to the system and avoids the need for extensive rewiring.

The GS Load Center (GSLC) can be equipped with bypass circuit breakers for this purpose. However, if multiple Radian inverters are stacked in a single system, then the GSLC bypass kits should not be used. The bypass function must be simultaneous for all inverters. The GSLC bypass kits operate independently, not simultaneously.

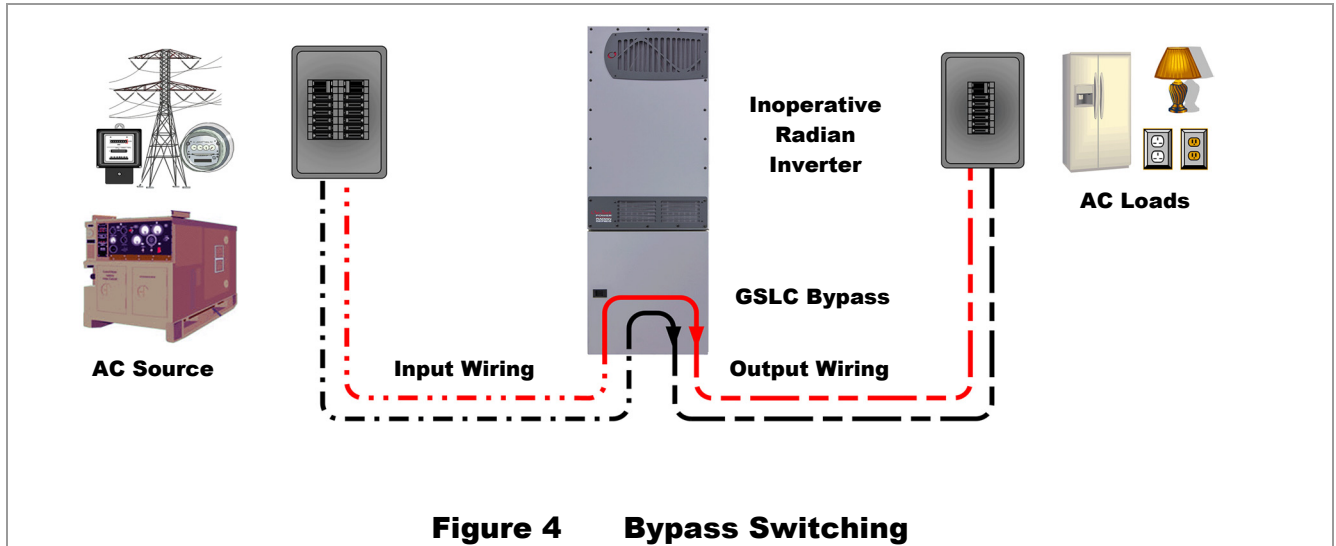

Both manual and automatic double-throw bypass switches are commonly available in a range of sizes and options. These are highly recommended for systems with more than a single inverter.

	<p>WARNING: Shock Hazard or Equipment Damage</p> <p>Using independent bypass devices on multiple inverters can result in power being routed to inappropriate places. This could create an electric shock hazard or damage the equipment.</p>
---	---

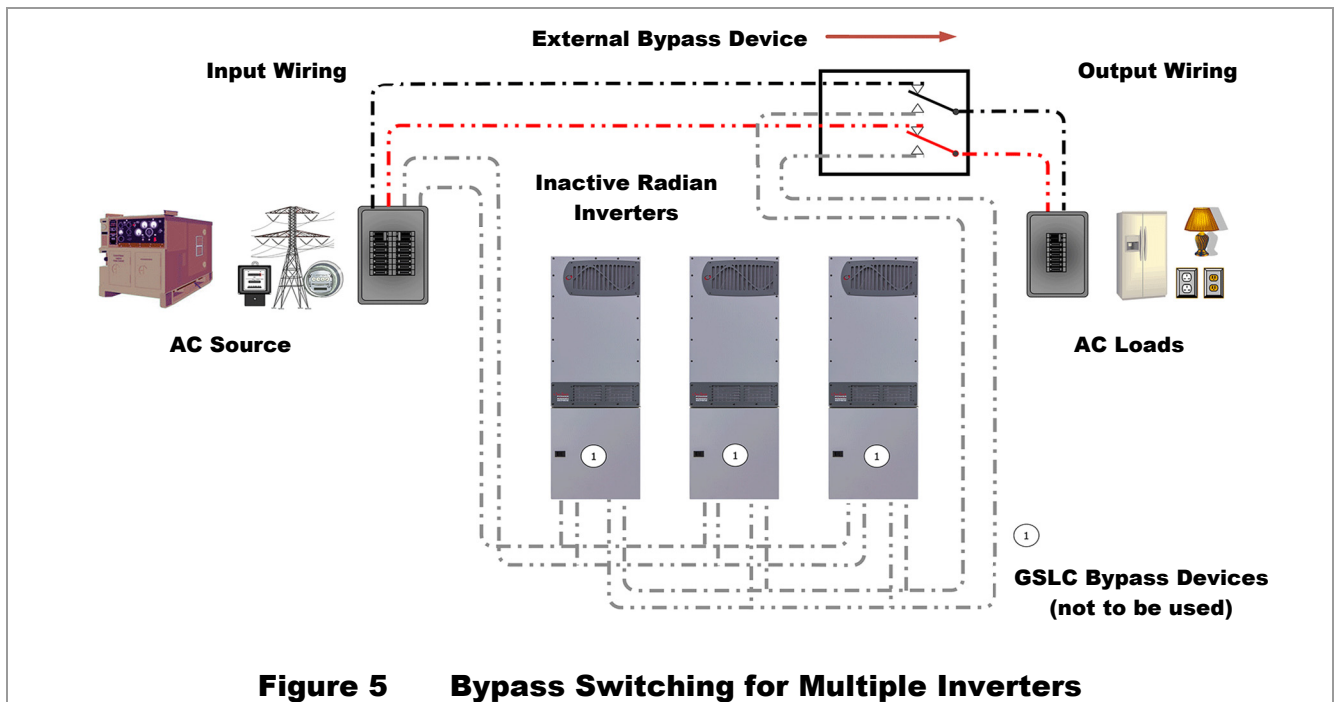



Installation

Location and Environmental Requirements

Radian series inverter/chargers must be located indoors or in a weather-proof enclosure. They are not designed for exposure to water, salt air, or excessive wind-blown dust and debris.

The Radian inverter must be wall-mounted in an upright position. The inverter is not approved for mounting in any other position or orientation.

- These inverters will perform more efficiently in locations offering plenty of air circulation. The minimum recommended clearance is 2 inches (5 cm) on all sides of the inverter.
- The sides and bottom may be enclosed or obscured with no restriction when mounting accessory devices or one other inverter. If more than two Radian inverters are installed side by side with the GSLC, the inverters should be separated by at least 0.9 inches (2.3 cm) to accommodate the GSLC hinged doors.
- These inverters will operate normally in a range of -4°F to 122°F (-20°C to 50°C). Maximum output will begin to decline at ambient temperatures above 25°F (77°C).
- The allowable temperature range for storage is -40°F to 140°F (-40°C to 60°C).
- These inverters carry an Ingress Protection (IP) rating of 20 and a Relative Humidity (RH) rating of 93% (non-condensing).
- The specifications are listed in the *Radian Series Inverter/Charger Operator's Manual*.

Dimensions

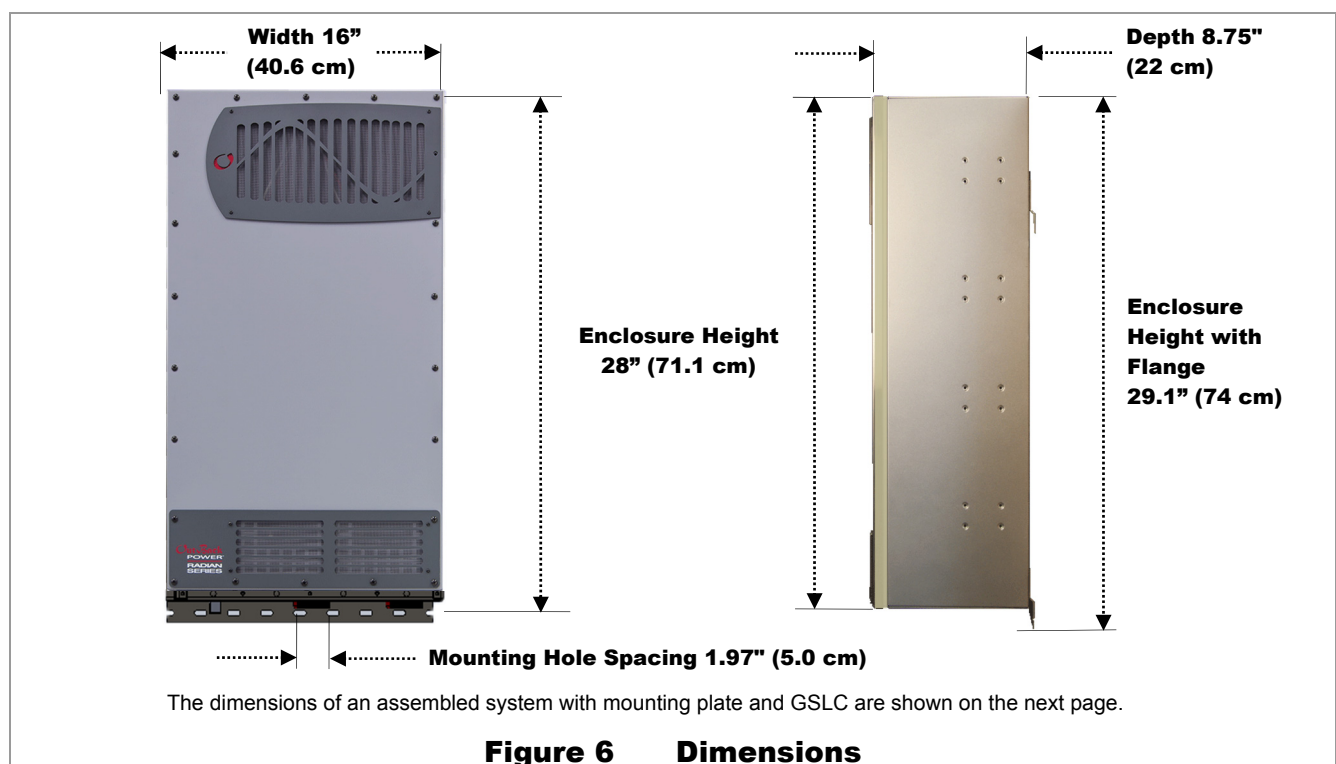

Installation

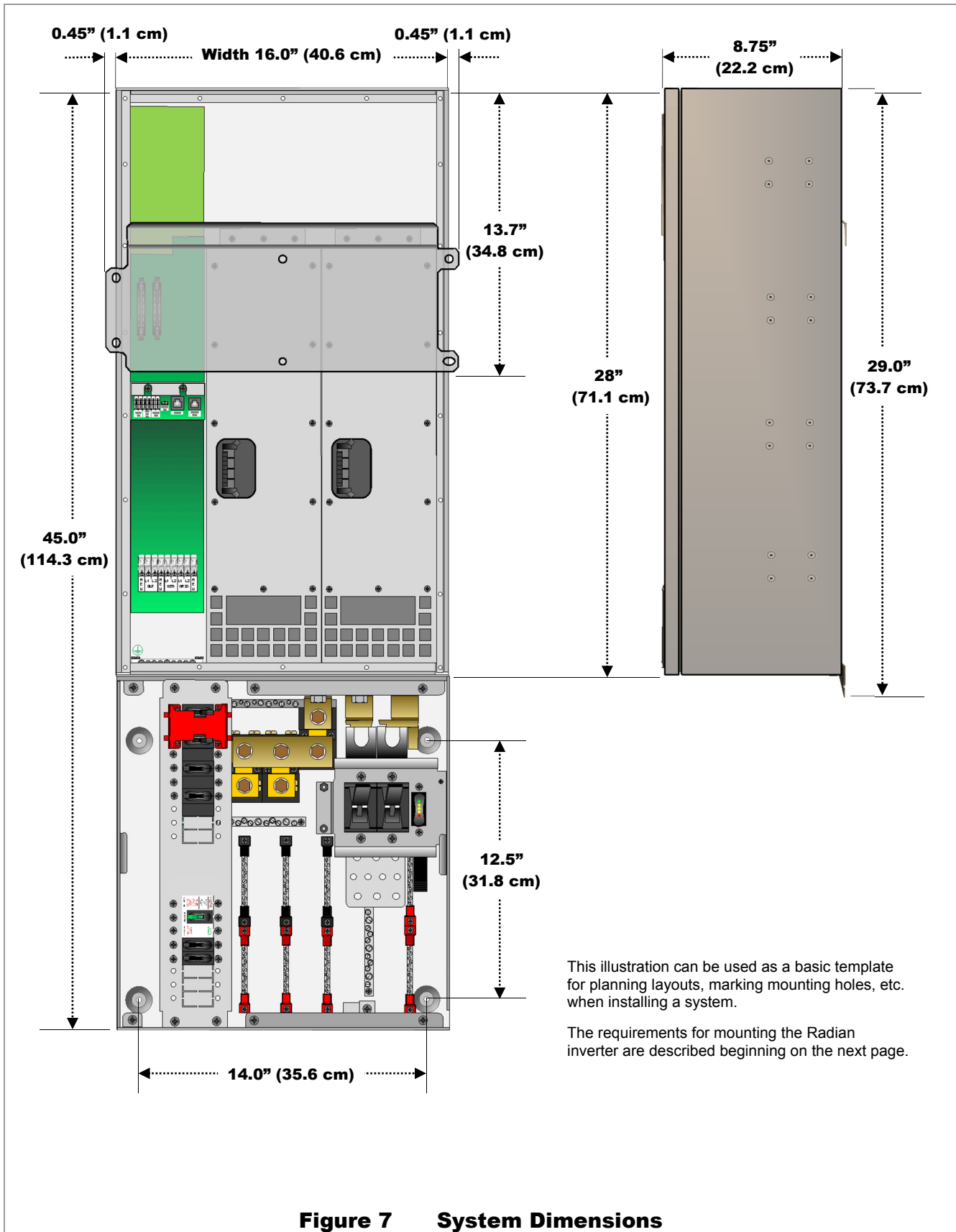

Figure 7 System Dimensions

Tools Required

The following tools may be required for this installation:

- Wrench and socket sets; should include
 - ~ torque and ratchet wrenches
 - ~ reversible (stubby) wrenches for narrow access
 - ~ offset box wrench, ½" or 13 mm
- Wire cutters/strippers
- Insulated screwdriver set (flat and Phillips; should include
 - ~ #2 Phillips screwdriver 15 to 16" long
- Long-nose pliers
- High-resolution voltmeter

Mounting

- Two or more people may be needed to install the Radian inverter/charger due to its weight.
- Mount and secure each component before attaching any wiring. Local or national wiring codes may require the bottom of the inverter to be enclosed. The GS Load Center was specifically designed for this purpose.
- Avoid large air gaps behind the Radian inverter/charger and its mounting plate. These can result in louder mechanical noise during heavy inverting or charging. Mount the plate on a flat, solid mounting surface.



IMPORTANT:

Use correct fasteners to secure the mounting plate and the Radian inverter/charger to the mounting surface. OutBack cannot be responsible for damage to the product if it is attached with inadequate fasteners.

The Radian inverter/charger comes equipped with a mounting plate, as shown in Figure 8.

Mount the Radian inverter using these steps.

1. The mounting plate is to be screwed or bolted directly to a solid mounting surface such as wall studs. Lag screws are provided for this purpose.
 - ~ The plate is designed to mount on wall studs with a spacing of 16" (40.6 cm). If the studs have a different spacing, plywood or similar material should be installed over the studs. This material should be ½" size or thicker. The mounting plate can be installed on the plywood surface.
 - ~ If multiple Radian inverter/chargers are being installed, all mounting plates should be installed first. The inverters can be mounted and secured one at a time when this is done.

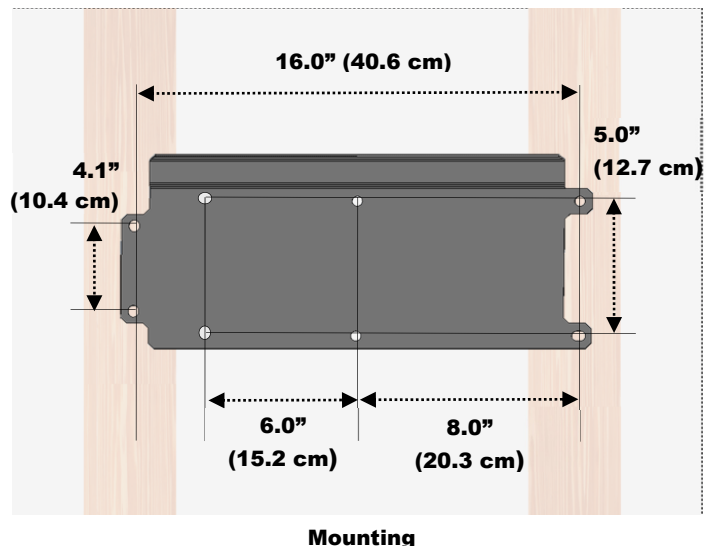

Continued on the next page...

Figure 8 Installing the Mounting Plate

Installation

...continued from the previous page...

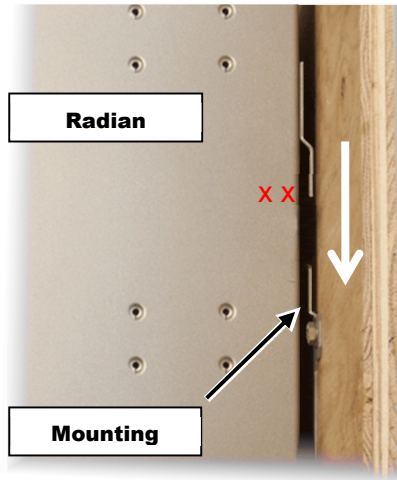

2. Place the Radian inverter against the wall and slide it directly over the upper lip of the mounting plate. The inverter's mounting flange should come to rest within the lip so that it hangs securely.

To assist in alignment, dimples have been placed on the side of the unit to mark the lower edge of the flange. In the picture to the left, the two **x** symbols show the location of the dimples.



3. Align the left edge of the inverter with the left edge of the mounting plate. This will expose the right edge of the plate, allowing easy installation of another Radian inverter/charger in the future. All additional inverters are mounted to the right of the existing unit.

The unit shown to the right is not aligned with the mounting plate, as the plate is still visible. In this example, it should slide to the left so that the plate is entirely covered.

NOTE: If the GS Load Center is used with the Radian inverter, the following step should be omitted.

4. Once aligned, secure the Radian inverter to the stud using a lag screw (provided) in the left corner of the inverter's bottom flange.

Securing the inverter this way will prevent it from dislodging from the mounting plate in the event of an earthquake or similar event.

NOTE: The left corner is used for securing the inverter to a stud. If the Radian inverter is mounted on plywood or a similar wide-area mounting surface as shown, any of the slots in the mounting flange may be used.



WARNING: Shock Hazard

When the inverter is used with other metal chassis, make sure that all chassis are grounded appropriately. (See the grounding instructions on page 24.) Grounding other chassis may involve metal-to-metal contact or separate ground wires.

Figure 9 Mounting the Inverter

Component Mounting

The top of the GS Load Center (GSLC)  connects to the bottom of the Radian inverter using four keyhole slots. The keyhole slots fit over four screws on the bottom of the inverter that secure the GSLC to the inverter when tightened. (The long screwdriver recommended on page 19 may be needed to reach these screws.) The GSLC should be secured to the wall using screws or wall anchors.

The GSLC also makes a mechanical connection to the Radian using bus bars that bolt to the inverter's DC terminals. Other connections are wired as necessary.

Several system components can mount directly onto the Radian inverter or the GSLC. A MATE3-class system display and the HUB Communications Manager can easily be mounted on the left side of the system. FLEXmax charge controllers can be mounted on its right side.

NOTE: The FLEXmax controller requires mounting brackets (see below). The conduit provided with these brackets is long enough to wire the FLEXmax directly to the GSLC. Additional conduit may be necessary when mounting on the inverter. The image on the right shows GSLC mounting. See Figure 2 on page 7 for other configurations.



For the MATE3s:
To fit on the Radian inverter's left side, the MATE3s requires the FW-MB3 mounting bracket. Holes are provided on the upper and lower left side to attach the FW-MB3. For more information, see the FW-MB3 instruction sheet.

For the HUB:
To fit on the Radian inverter's left side, the HUB uses two mounting holes and three knockouts.

For the FLEXmax charge controller:
To fit on the inverter's right side, FLEXmax charge controllers require the FW-CCB or FW-CCB2 mounting brackets. To assist many possible mounting requirements, four sets of mounting holes have been provided for the brackets.

NOTE: The OutBack FLEXmax 100 should be installed on the wall to either side of the GSLC for direct wiring access and does not require additional brackets.

Figure 10 Mounting for System Components

Removing Front Cover

The front cover must be removed in order to access the Radian inverter's AC terminals and other connections. These include the **REMOTE** and **BATT TEMP** ports, as well as several sets of auxiliary terminals.

Twenty-two machine screws are located around the perimeter. Remove these screws with a #2 Phillips screwdriver. Once they are removed, the cover can be lifted off.

NOTE: The screws which secure the plastic plates to the cover do not need to be removed.

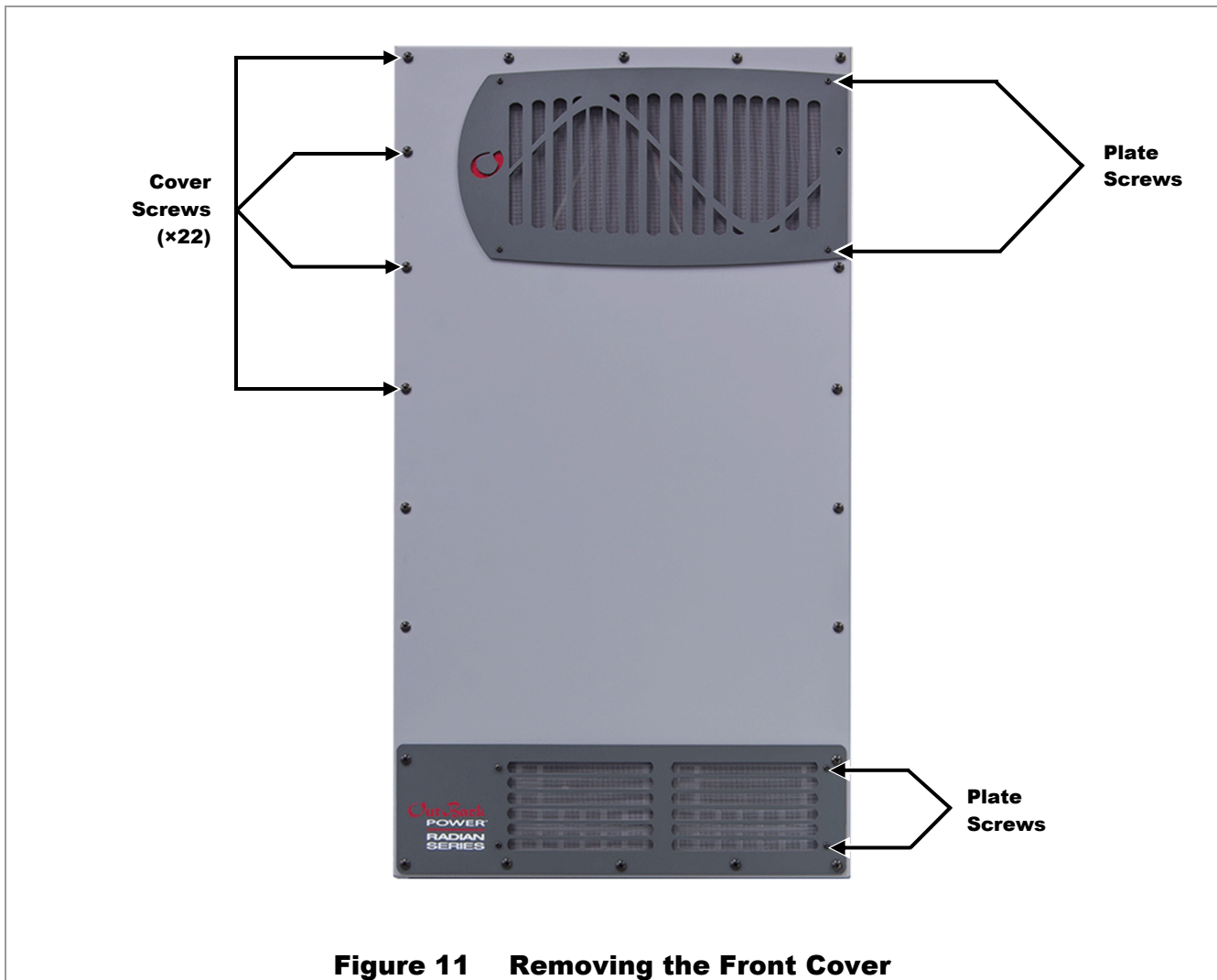

Figure 11 Removing the Front Cover



NOTE:

The Radian inverter may ship with only a few screws installed to make it easier to perform the initial installation. The remaining screws are included in the hardware kit.

Terminals and Ports

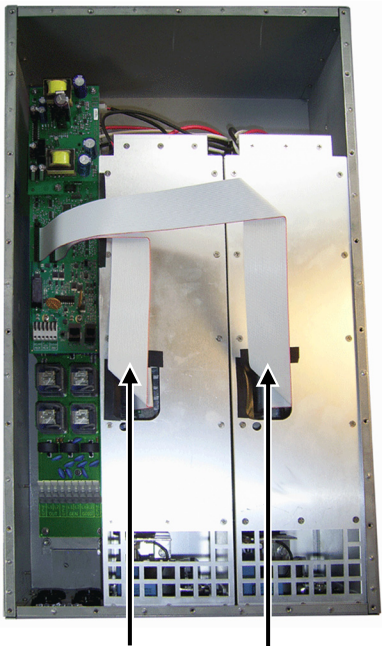

RIBBON CABLES: Connects the Radian's power modules and control board. See **Warning** below.



DC TERMINALS: Connects to the battery cables and DC system. There are two DC positive and two DC negative terminals. Each DC positive terminal requires separate cables and separate overcurrent protection. See page 26 for instructions.

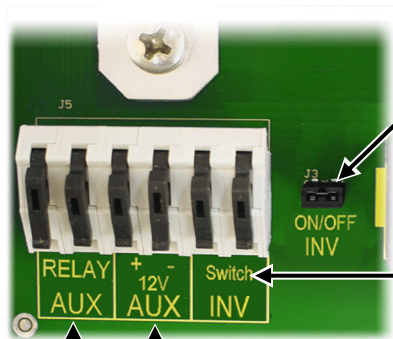

RELAY AUX: Relay contacts with no voltage (10 amps at 250 Vac or 30 Vdc). The relay can be switched on and off for many functions. See page 33 for details.

12V AUX: Delivers 12 Vdc up to 0.7 amps (8.4 watts). The output can be switched on and off for many functions. See page 33 for details.

ON/OFF INV JUMPER (J3): Overrides the **SWITCH INV** terminals when installed. When installed, the inverter is On. The On or Off states can then only be controlled by the system display.

NOTE: J3 is installed to the **ON** position during manufacture, but the Radian inverter is given an external **OFF** command at the same time. Its initial state will be Off.

SWITCH INV: Receives wires for a manual on/off switch to control the inverter. See page 32 for instructions.

NOTE: The **ON/OFF INV** jumper (J3) overrides these terminals when installed. (See above.)

The functions for each set of **AUX** contacts can be programmed using the system display.

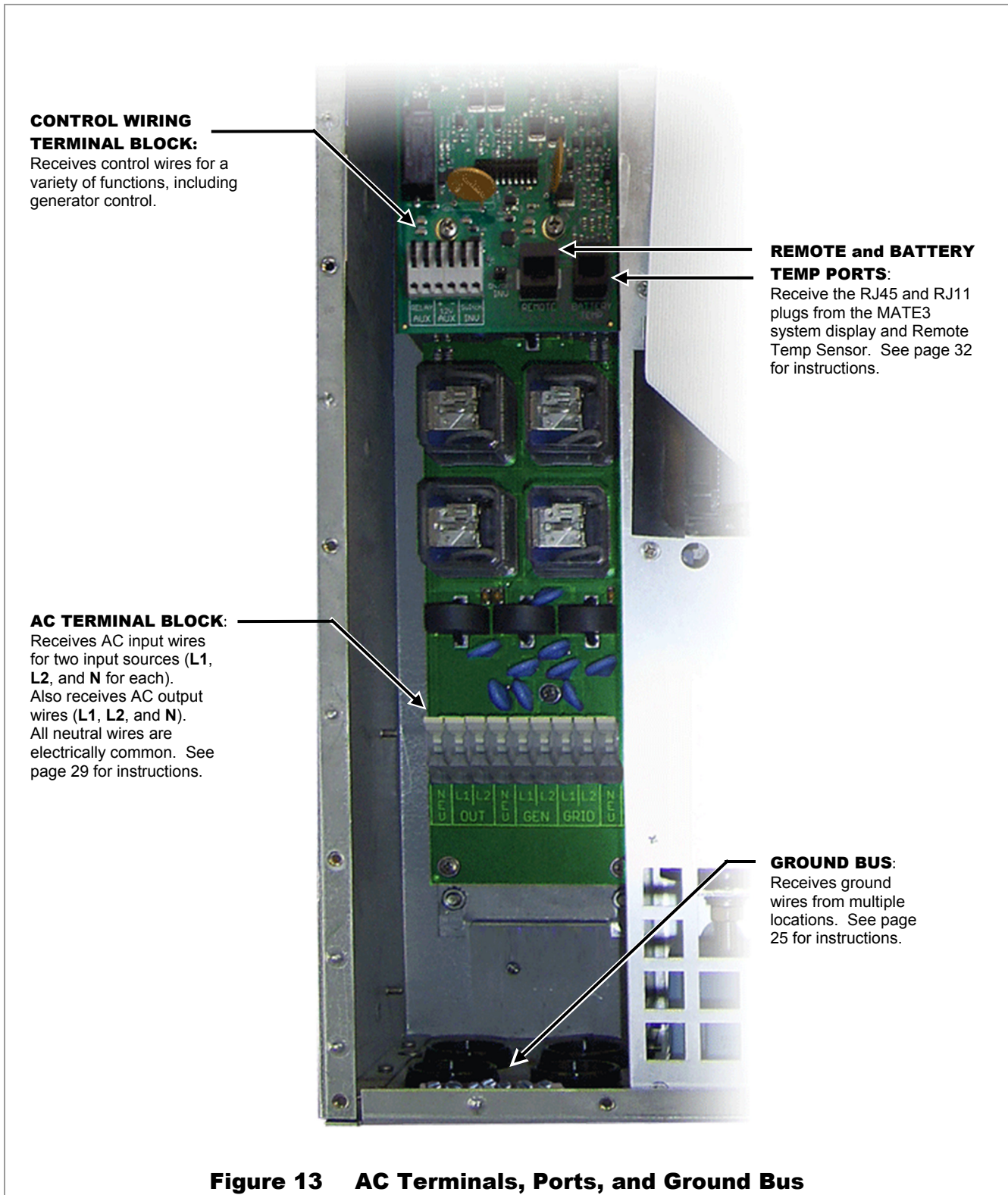

Figure 12 DC Terminals, Ribbon Cables, and Auxiliary Terminals



WARNING: Shock Hazard and Equipment Damage

It may be necessary to remove the ribbon cables in the course of servicing the Radian. (This is detailed in the Radian service manual.) The cables must never be removed until all power has been disconnected for a minimum of one minute. If the cables are removed prematurely, the Radian's capacitors will retain a sizable charge, which can cause electrical shock or severe equipment damage during normal handling. This damage is not covered under the unit's warranty.



WARNING: Shock Hazard

After installation, do not remove the covers while the inverter has any source of power. See the *Operator's Manual* for the shutdown procedure before removing the covers.

Wiring

It will be necessary to remove knockouts from the chassis to run wires. Bushings are included with the hardware kit to protect the wires. Make sure to install these bushings in the holes.

Use copper wire only. Wire must be rated at 75°C or higher.

Grounding



	<p>WARNING: Shock Hazard</p> <ul style="list-style-type: none"> ❖ This unit meets the IEC requirements of Protection Class I. ❖ The unit must be connected to a permanent wiring system that is grounded according to the IEC 60364 TN standard. ❖ The input and output circuits are isolated from ground. The installer is responsible for system grounding according to all applicable codes. ❖ For safety, the neutral and ground conductors should be mechanically bonded. OutBack does not bond these conductors within the inverter. Make sure that no more than one bond is present in the AC system at any time. Some codes require the bond to be made at the main panel only. ❖ The GS Load Center (GSLC) is equipped with a neutral-ground bond. If bonding is required to be in another location, the bond in the GSLC may need to be removed.
	<p>WARNING: Shock Hazard</p> <p>For all installations, the negative battery conductor should be bonded to the grounding system at only one point. If the OutBack GFDI is present, it provides the bond. (The GSLC is also equipped with its own bond, which may need to be removed.)</p>
	<p>IMPORTANT:</p> <p>Most OutBack products are not designed for use in a positive-grounded system. If it is necessary to build a positive-grounded system with OutBack products, see the Positive Grounding applications note at www.outbackpower.com.</p>

Table 3 Ground Conductor Size and Torque Requirements

Terminal Location	Minimum Conductor Size	Torque Requirements
Ground TBB	#8 AWG (0.013 in ²) or 10 mm ²	25 in-lb (2.8 Nm)





The inverter's ground terminal bus bar (TBB) may be used for making all ground connections to other parts of the system. Examples include inverter equipment grounding, generator grounding, load panel grounding, and main earth ground wire. When the GSLC is used, make a connection from the inverter to the ground TBB in the GSLC.

This TBB accepts up to #4 AWG (0.033 in²) or 25 mm² wire.



Figure 14 Chassis Ground TBB

DC Wiring

	<p>WARNING: Shock Hazard</p> <p>Use caution when working in the vicinity of the inverter's battery terminals.</p>
	<p>CAUTION: Equipment Damage</p> <p>Never reverse the polarity of the battery cables. Always ensure correct polarity.</p>
	<p>CAUTION: Fire Hazard</p> <ul style="list-style-type: none"> ❖ The installer is responsible for providing overcurrent protection. Install a circuit breaker or overcurrent device on each DC positive (+) conductor to protect the DC system. ❖ Never install extra washers or hardware between the mounting surface and the battery cable lug. The decreased surface area can build up heat. See the hardware diagrams on page 28.
	<p>IMPORTANT:</p> <ul style="list-style-type: none"> ❖ The DC terminals must be encased in an enclosure to meet NEC requirements. The GS Load Center (GSLC) meets this requirement. ❖ Table 4 contains OutBack's recommendations for minimum cable sizes. Other codes may supersede OutBack's requirements. Consult local codes for final size requirements.

The following notes are depicted in Figure 15 on the next page.

	<p>IMPORTANT:</p> <ul style="list-style-type: none"> ❖ The Radian GS8048A contains two internal power modules, each with its own set of DC terminals. Both sets of terminals must be connected to battery power for the inverter to work correctly. ❖ The Radian GS4048A contains a single power module which occupies the space on the left. Although it has two pairs of terminals, only the pair on the left is functional. The battery cables must be connected to these terminals. The terminals on the right must not be connected to battery power.
---	---



Table 4 DC Conductor Size and Torque Requirements

Inverter	Nominal DC Amps (Minimum, per breaker) (Derated 125%)	Conductor Size (Minimum, per breaker)	Breaker Size
GS8048A	104	2/0 AWG (0.109 in ²) or 70 mm ²	175 Adc/AIC 10kA
GS4048A	104	2/0 AWG (0.109 in ²) or 70 mm ²	175 Adc/AIC 10kA
Terminal Location		Torque Requirements	
Inverter DC Terminals		60 in-lb (6.9 Nm)	
Battery Terminals		See battery manufacturer's recommendations	

When installing DC cables:

- Turn off DC circuit breakers before proceeding.
- Battery positive (+) and negative (-) cables should be no longer than 10 feet (3 meters) each. This helps to minimize voltage loss and other possible effects.
- The modular construction of the GS8048A requires the use of two DC circuit breakers.
- The cables for each overcurrent device must each be sized appropriately. Alternately, a single cable or bus may be used if sized to the minimum total ampacity. The cables listed above are for each inverter in a system. In a multiple-inverter system, each inverter requires its own cables and overcurrent devices of the size indicated.
- Install all overcurrent devices on the positive cable.
- Tie, tape, or twist positive and negative cables together to reduce self-inductance. Run positive and negative cables through the same knockouts and conduit.



IMPORTANT:

Do not install hardware in a different order from the illustrations shown in Figure 16. In all cases the battery cable lug must be the first item installed. It must make solid contact with the surface.

Installation

- If the battery cables are connected directly to the Radian inverter, the hardware should be arranged as shown in image **A**. The inverter's battery terminal is a threaded hole which accepts a hex bolt (provided). The battery cable lug must have a 0.79 cm (5/16") diameter hole.
- If the inverter is installed with the GS Load Center (GSLC), follow GSLC instructions for hardware installation. The hardware should be arranged according to the appropriate image below. 
- GSLC models used with the GS8048A inverter are equipped with a DC positive (+) plate. The plate accepts an M8 hex bolt and nut. See image **B**.
- GSLC models used with the GS4048A inverter do not use the DC positive plate. The cable lugs are connected to the DC disconnect, which uses a threaded M8 stud. See image **C**.
- All GSLC models connect the battery negative cables to the shunt, which is threaded for 3/8" bolts. See image **D**.

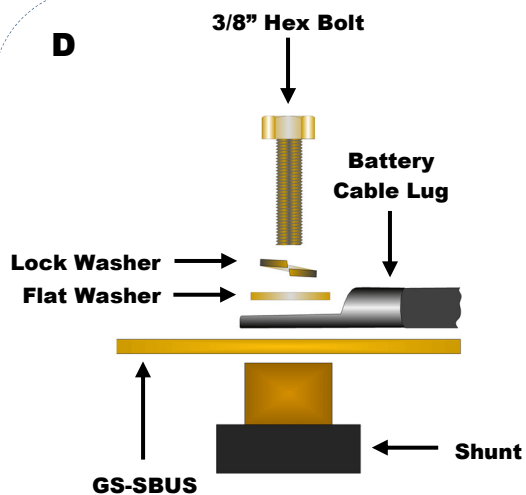
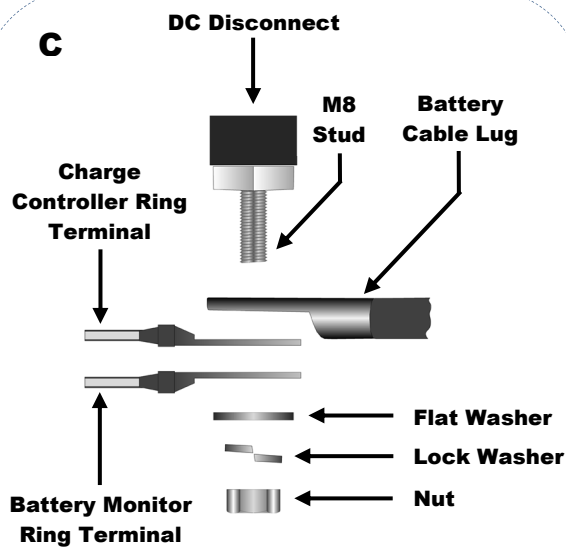
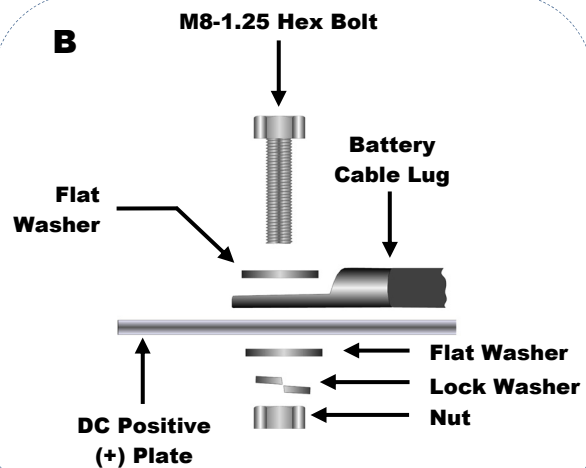
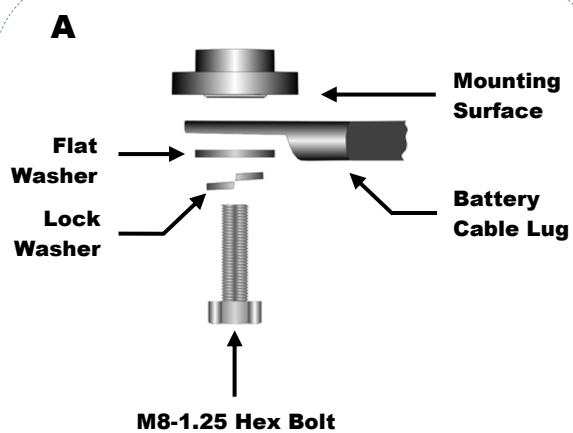

Figure 16 DC Cable Hardware (Radian inverter)

AC Wiring



	<p>WARNING: Shock Hazard</p> <ul style="list-style-type: none"> ❖ The neutral and ground conductors should be mechanically bonded. Ensure there is no more than one AC neutral-ground bond at any time. ❖ Local or national codes may require the bond to be made at the main panel only. The GS Load Center (GSLC) is equipped with its own bond, which may need to be removed.
	<p>CAUTION: Equipment Damage</p> <p>The Radian inverter cannot be connected to a three-phase source (utility grid or generator). The L1 and L2 inputs cannot be connected to two lines of a three-phase power source.</p>
	<p>IMPORTANT:</p> <p>The installer is responsible for providing overcurrent protection. The AC input and output must be protected with branch-rated circuit breakers of up to 50 Aac maximum size to meet applicable code requirements.</p>
	<p>NOTE:</p> <p>The use of a GFCI-equipped AC source to power either the GRID or GEN input is not recommended.</p>

All system wiring must comply with national and local codes and regulations.

The Radian inverter/charger's AC terminal block has nine positions for AC wires. The minimum recommended wire size is #8 AWG (0.013 in²) or 10 mm². Larger wire gauges may be required for specific conditions. The largest size that can be used with the terminals is #6 AWG (0.021 in²) or 16 mm² wire.

The inverter makes its AC connections using spring-loaded clamps. It is necessary to strip approximately ½ inch (1.3 cm) of insulation from the end of each wire. Other tools are not required.

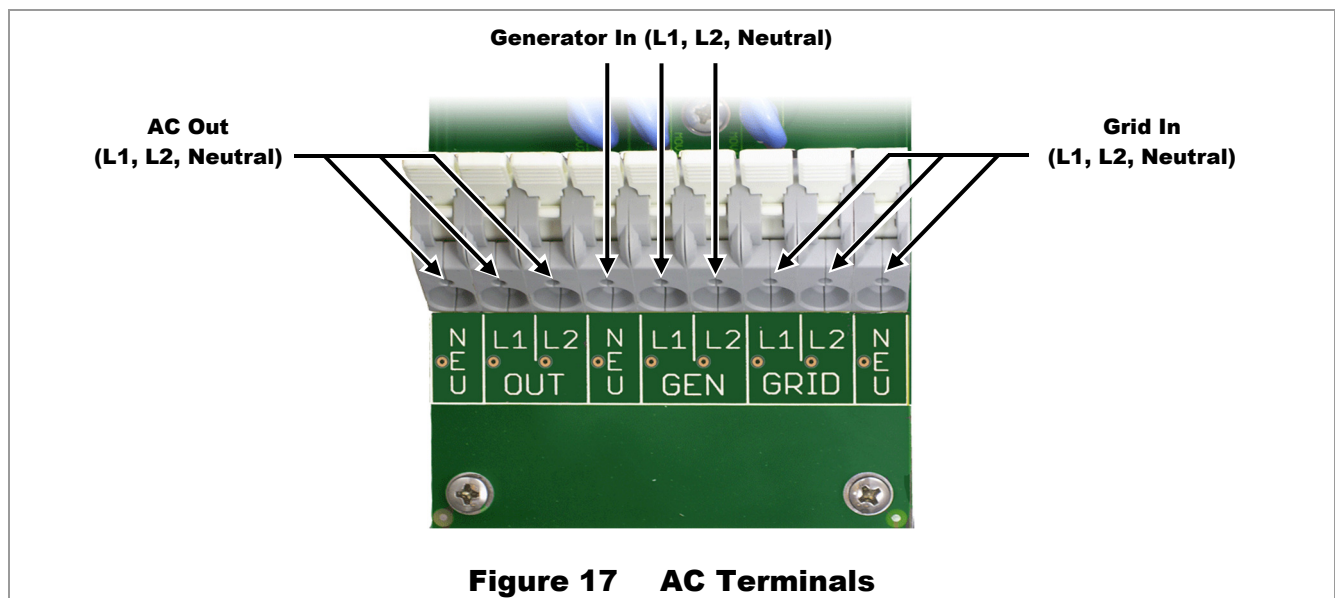

The terminals labeled **L1** and **L2 GRID** are used to connect to the two utility grid “hot” wires. The **L1** and **L2** wires are usually black and red respectively, and read 120 Vac each when measured with respect to neutral. In a standard service, **L1** and **L2** are 180 degrees out of phase and should read 240 Vac when measured from one to the other.

Installation

The **L1** and **L2 GEN** terminals are used to connect to the “hot” wires on a 120/240 Vac generator.

Three neutral (**N**) terminals are available. These terminals are electrically common. Any of them can be used to connect to neutral wires from various parts of the system. The most common connections are to the neutral bus on the main panel or utility grid service, the neutral bus on the output load panel, the neutral bus in the GSLC, and the neutral wire from a generator.

The Radian can accept input voltages that range between (nominal) 100/200 Vac and 120/240 Vac (split-phase only). The range of input acceptance may need to be adjusted to the nominal voltage of the system so that inappropriate voltages are not accepted.

The AC source(s) can power both battery charger and loads if sized correctly. Use the source amperage and the charger size to determine actual maximum draw. Size the input circuit breakers according to these specifications.

The terminals labeled **OUT** are used to connect the Radian inverter to the load circuits. These terminals also transfer power from an input source if it is available. (See the next page.) Size the load circuit breakers accordingly.

A Ground Terminal Bus Bar (TBB) is also available if multiple ground connections are needed (see Figure 14 on page 25).



WARNING: Shock Hazard



During an error shutdown, the inverter's output terminals are not live. However, if the inverter recovers from a shutdown, the terminals will become live without notice. Several error shutdowns can be recovered automatically, including **Low Battery V**, **High Battery V**, and **Over Temperature**. See the Troubleshooting section and the list of error messages in the *Radian Series Inverter/Charger Operator's Manual* for more information.

AC Sources

The inverter's transfer relay is normally set to provide inverter power to the output. The conditions for AC acceptance are defined by the inverter's programmed settings and AC input mode. The relay will switch to transfer the AC source power to the output when the AC acceptance conditions are met. 

The Radian inverter has connections for two AC sources, **GEN** (generator) and **GRID**, for ease of installation. The Radian transfers each source with a separate relay. However, internally it can only connect to one AC source at a time. It cannot use both grid and generator power at the same time. If presented with two sources of power, the default setting is to accept the source connected to the **GRID** terminals. The source priority can be changed using the system display. 

NOTE: The terminals are labeled due to common conventions, not inverter requirements. The **GEN** terminals can accept grid power if necessary. The opposite is also true. Each input can accept any AC source as long as it meets the requirements of the Radian and the selected input mode, with the following exception.

	<p>IMPORTANT:</p> <p>The generator must be connected to the GEN terminals if using either the MATE3's Advanced Generator Start (AGS) function or the Radian's GenAlert auxiliary function. If the input priority is set to GRID and the GRID terminals are energized, an automatically controlled generator will shut down. This prevents an automatic generator from working correctly when using the GRID terminals.</p>
	<p>NOTE:</p> <p>If an AC source is present on the priority input, the second input cannot accept another source for any reason. This is true even if the inverter has not accepted the priority source. The behavior is the same whether the first source was rejected for quality issues or because of programmed settings.</p>

In Figure 18, the arrow between the output neutral and ground wires indicates that these two wires have been bonded together, usually at the main electrical panel. Only one bond should be made between neutral and ground at any time. See pages 25 and 29. If a generator is present in a permanent installation, the generator's neutral and ground should be isolated.

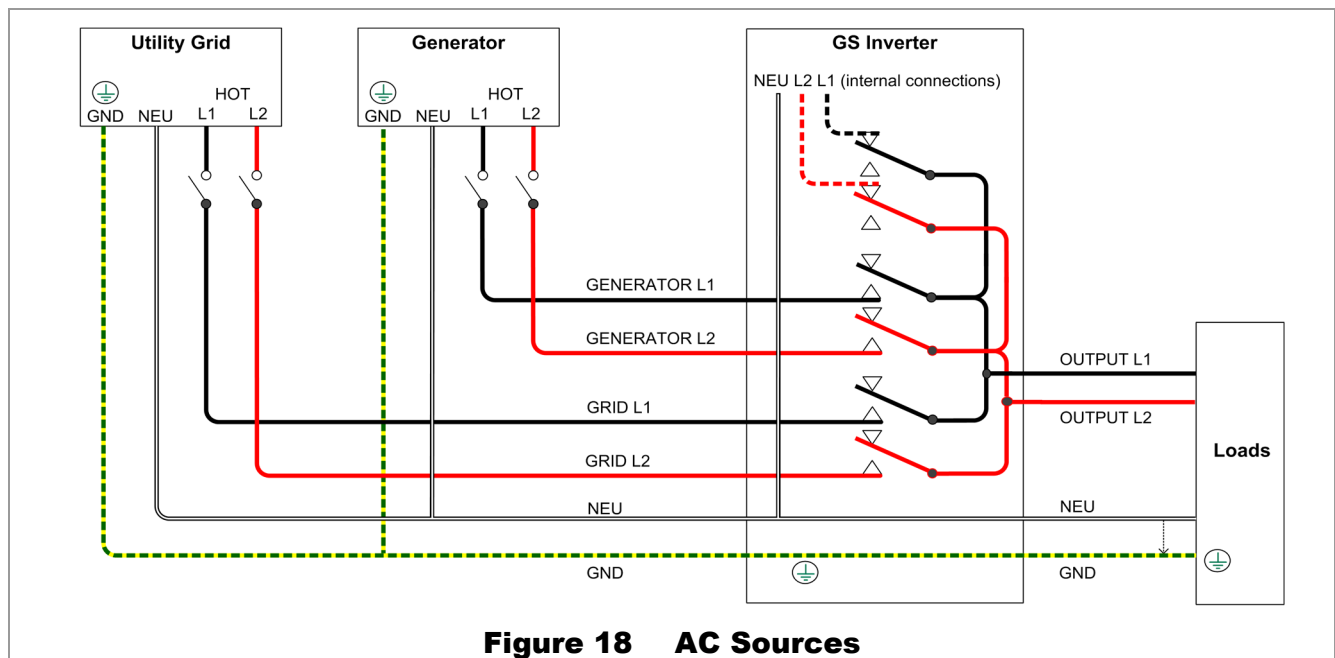
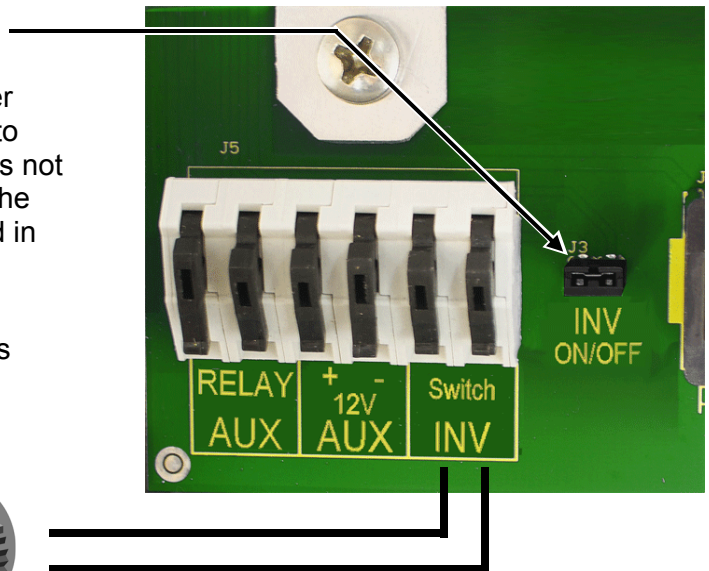

Figure 18 AC Sources

ON and OFF Wiring

The **INV ON/OFF** jumper bridges two pins. This jumper (J3) parallels the two **SWITCH INV** terminals on the terminal block. If either connection is closed, this sets the inverter to On as long as the internal programming has not been set to Off with the system display. (The inverter is given an external **OFF** command in the factory. Its initial state will be Off.)

An inverter in the Off state will not invert. However, it may still transfer power to loads and charge batteries from an AC source.



Jumper On

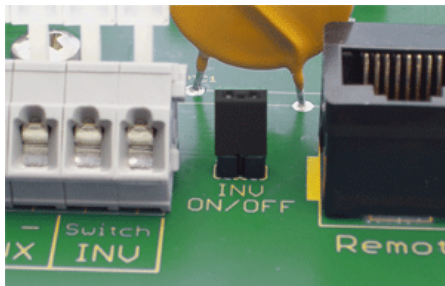

Jumper Off

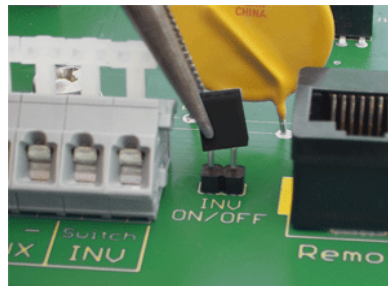

If the system display is not present:

To turn the inverter initially On, remove the jumper briefly and then replace it. This requires long-nose pliers or a similar tool. (This will change the internal programmed state to On.) After this, removing the jumper will immediately turn the inverter Off.

Once the plastic **INV ON/OFF** jumper has been removed, the **SWITCH INV** terminals on the terminal block can be used to wire a manual on/off switch or an emergency shutoff.

Figure 19 ON/OFF Jumper and Connections

Accessory Wiring

The upper board has ports for both the Remote Temperature Sensor (RTS) and the system display. The system display port is labeled **REMOTE**. The RTS port is labeled **BATTERY TEMP**. See the *Operator's Manual* for functional information on the RTS.

RTS cable
(RJ11, 4-conductor, telephone)

MATE3 or HUB cable
(RJ45, 8-conductor, CAT5 non-crossover)

If a HUB Communications Manager is in use, it occupies the inverter's **REMOTE** port. The system display plugs into the HUB product.

Inverters connect to communications manager  ports 1 and above. Charge controllers and other devices connect to additional ports after the last inverter is connected. See **Stacking** on page 40 for information on connecting inverters.

Figure 20 Accessory Connections

AUX Wiring

The Radian inverter has two sets of terminals which can respond to different criteria and control many functions. These include cooling fans, vent fans, load diversion, fault alarms, and the Advanced Generator Start (AGS) function.

The **12V AUX** terminals are a switched 12 Vdc power supply. They can supply up to 0.7 amps at 12 Vdc (8.4 watts). This is sufficient to drive a small fan or a relay controlling a larger device. The terminals accept wire up to #14 AWG (0.0032 in²) or 2.5 mm². This circuit contains electronic overcurrent protection, which resets after being overloaded. No additional fuses are required for the **12V AUX** terminals.

The **RELAY AUX** terminals are “dry” relay contacts with no voltage. Their most common function is to serve as a switch for the start circuit of an automatic generator using the generator control functions. However, they can be programmed for other auxiliary functions as well. These terminals can conduct up to 10 amps at up to 30 Vdc or 250 Vac.



CAUTION: Equipment Damage

This circuit has no overcurrent protection. A fuse of no larger than 10 amps must be installed to protect the circuit. Since the internal circuitry of the **RELAY AUX** terminals does not incorporate overcurrent protection, it is the responsibility of the installer to ensure the circuit is protected. Internal failure that results from lack of protection is not covered by the Radian warranty.

Each set of terminals has its own set of programmed criteria.

Installation



NOTE:

The menus for each set of terminals have identical options available, but can control independent functions. For example, the **RELAY AUX** terminals can be used for generator control, while the **12V AUX** terminals can simultaneously be used to control a vent fan in the battery box.

The control logic for the **AUX** output may be located in the inverter or it may be in the system display or another location. Radian **AUX** functions are located in the inverter and are described accordingly. Although inverter-based functions require the system display for programming, they will function even if it is removed. However, AGS programming is located within the system display even though it uses the Radian **AUX** terminals. It will not work if the display is removed. (Other devices may also be able to control the terminals.) For generator control, see page 35.

In this example, the **12V AUX** terminals directly drive a 12-volt vent fan. The + and – wires on the fan are connected to the **AUX** terminals.

NOTE: If another device is used, such as a larger fan, it must not draw more than 0.7 amps.



Figure 21 AUX Connections for Vent Fan (Example)

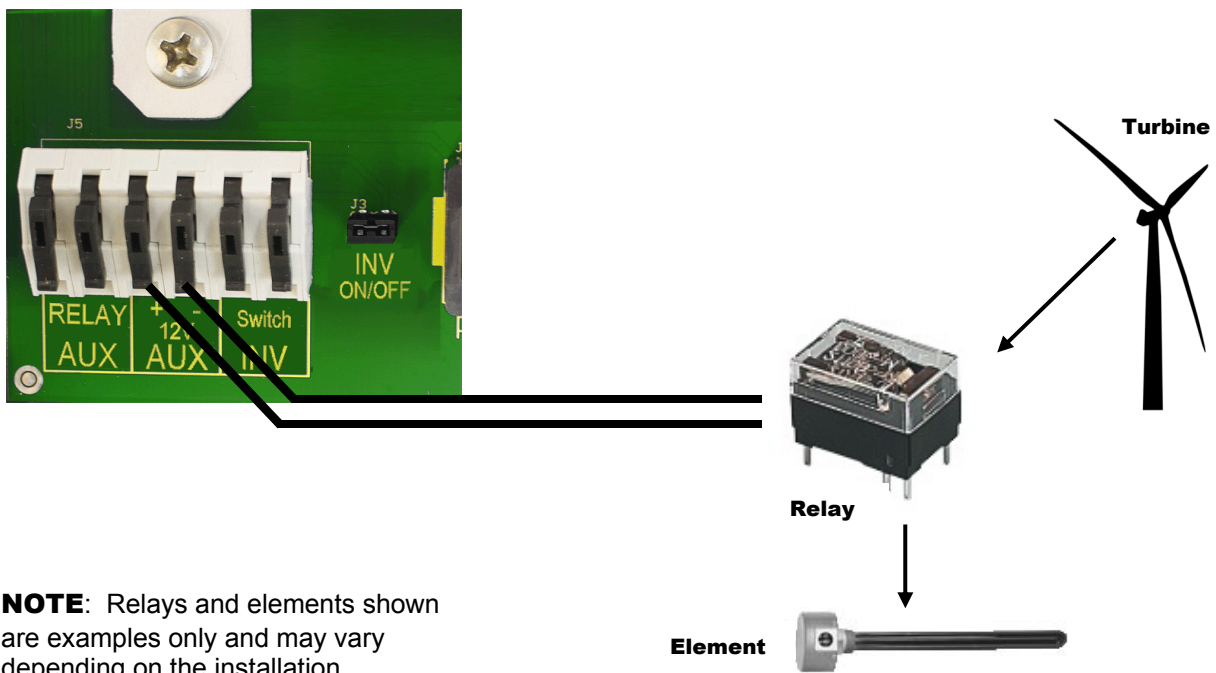

NOTE: Relays and elements shown are examples only and may vary depending on the installation.

Figure 22 AUX Connections for Diversion (Example)

Generator Control

Either set of Radian **AUX** terminals can provide a signal to control an automatic-start generator. The control function can be **Advanced Generator Start (AGS)**, which is situated in the system display. AGS can start the generator using settings from the system display, or it can use battery readings from the FLEXnet DC battery monitor. Note that AGS cannot be used if the system display is removed.

Alternately, the control function can be **Gen Alert**, which is a simpler function based directly in the inverter. The choice of function depends on system needs and the capabilities of each device.

The generator must be an electric-start model with automatic choke. It is recommended to have “two-wire” start capability.

The **RELAY AUX** terminals can most easily perform two-wire generator start. A two-wire-start generator is the simplest type, where the cranking and starting routine is automated. It usually has a single switch with two positions that is turned **ON** to start, **OFF** to stop.

Two-Wire Start (RELAY AUX Terminals)

The **RELAY AUX** terminals can be wired in place of the generator’s start switch as shown in Figure 23. This method is only advised if the generator’s starting circuit is triggered by continuity. (This circuit must use fewer than 10 amps.)



CAUTION: Equipment Damage

This circuit has no overcurrent protection. A fuse of no larger than 10 amps must be installed to protect the circuit. Since the internal circuitry of the **RELAY AUX** terminals does not incorporate overcurrent protection, it is the responsibility of the installer to ensure the circuit is protected. Internal failure that results from lack of protection is not covered by the Radian warranty.

In other cases, or in the case of a three-wire-start generator, the inverter should use the **12V AUX** terminals instead, in conjunction with a three-to-two wire converter. (See pages 36 and 37.)

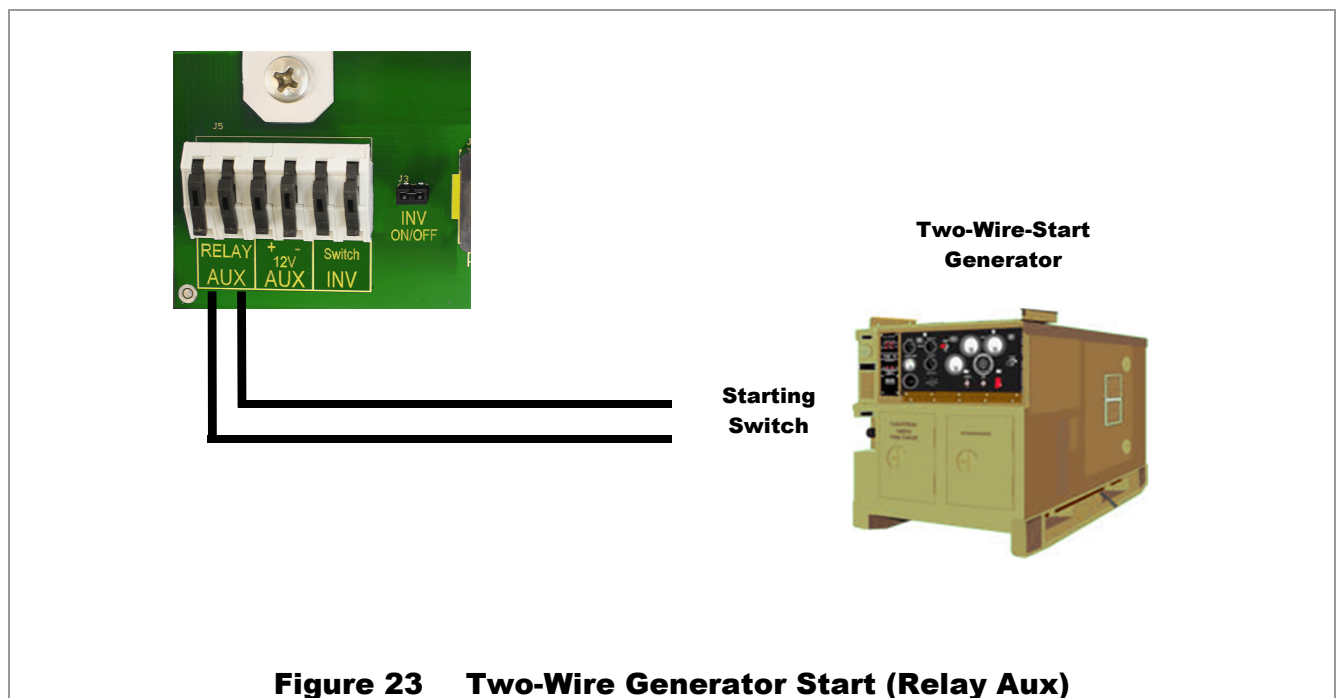

Figure 23 Two-Wire Generator Start (Relay Aux)

Two-Wire Start (12V AUX Terminals)

The 12 Vdc signal provided by the **12V AUX** terminals can be switched on and off to provide a start signal. It is not usually recommended to connect the **AUX** terminals directly to the generator, but to use the **12V AUX** terminals to energize the coil of a 12 Vdc automotive or similar relay.

The OutBack FLEXware Relay Assembly depicted in Figure 24 is sold for this purpose. The relay contacts can serve in place of the generator's start switch. The battery shown below (①) is depicted for clarity. In most cases the battery is part of the generator's internal starting circuit and is not an external component.

The drawing below is one example of a possible arrangement. Specific arrangements, relays, and other elements depend on the requirements of the installation and of the generator.

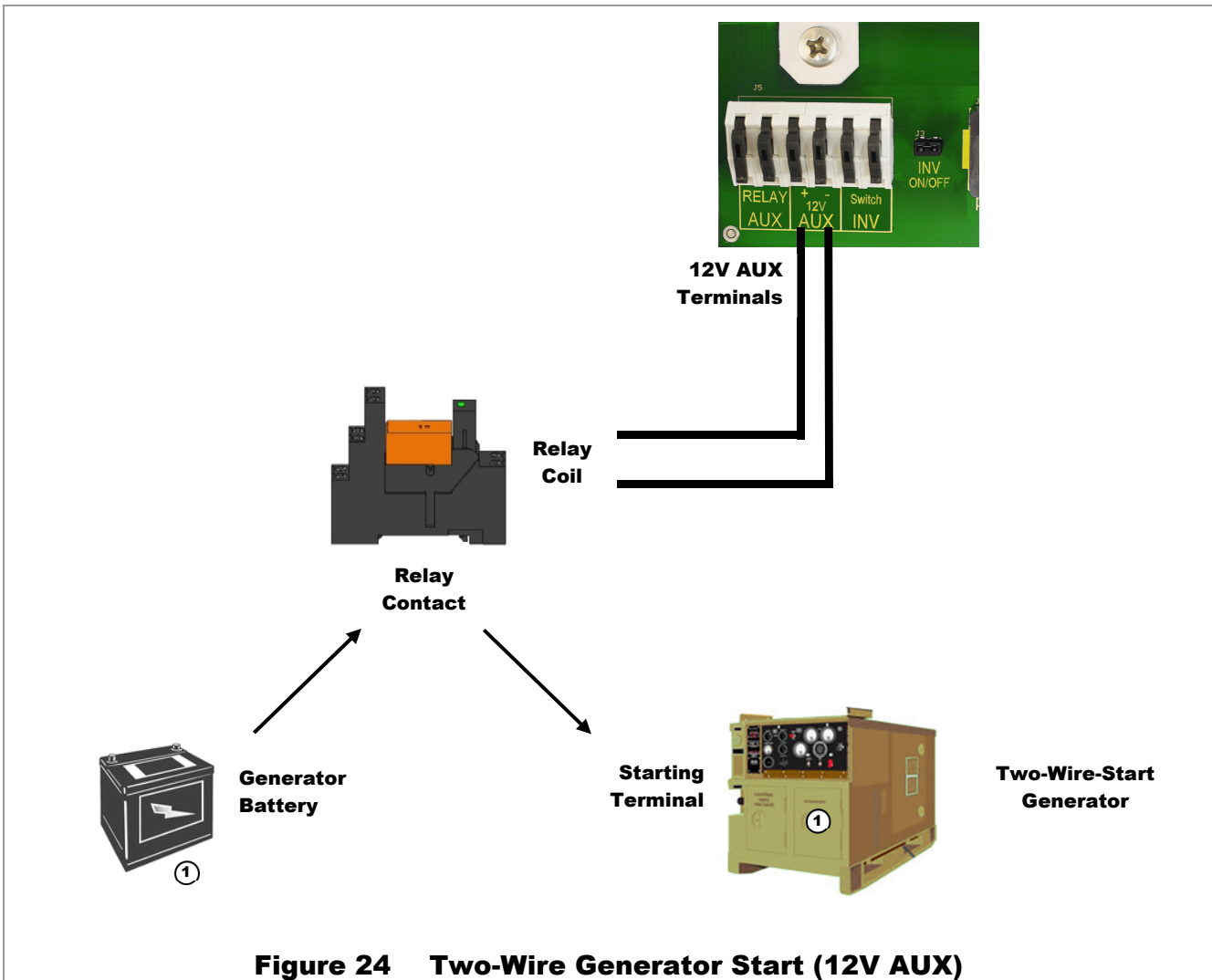

Three-Wire Start

A “three-wire-start” generator has two or more starting circuits. It usually has a separate switch or position for cranking the generator. A generator with three-wire start has fewer automated functions than a two-wire-start generator. It usually requires multiple controls for starting, running, or stopping. The inverter terminals cannot control this type of generator without using a three-wire to two-wire conversion kit.

Atkinson Electronics (<http://atkinsonelectronics.com>) is one company that makes these kits. The Atkinson GSCM-Mini is intended to work with OutBack inverters.

NOTE: The conversion kit requires a 12-volt signal which the **RELAY AUX** terminals cannot provide. The **12V AUX** terminals may be used to operate the conversion kit as shown in Figure 25 .

If the **AUX** terminals are being used for another purpose, it may be necessary for the **RELAY AUX** terminals to control an external relay and 12-volt source in conjunction with the conversion kit. The wiring and requirements for this arrangement will depend on the circumstances.

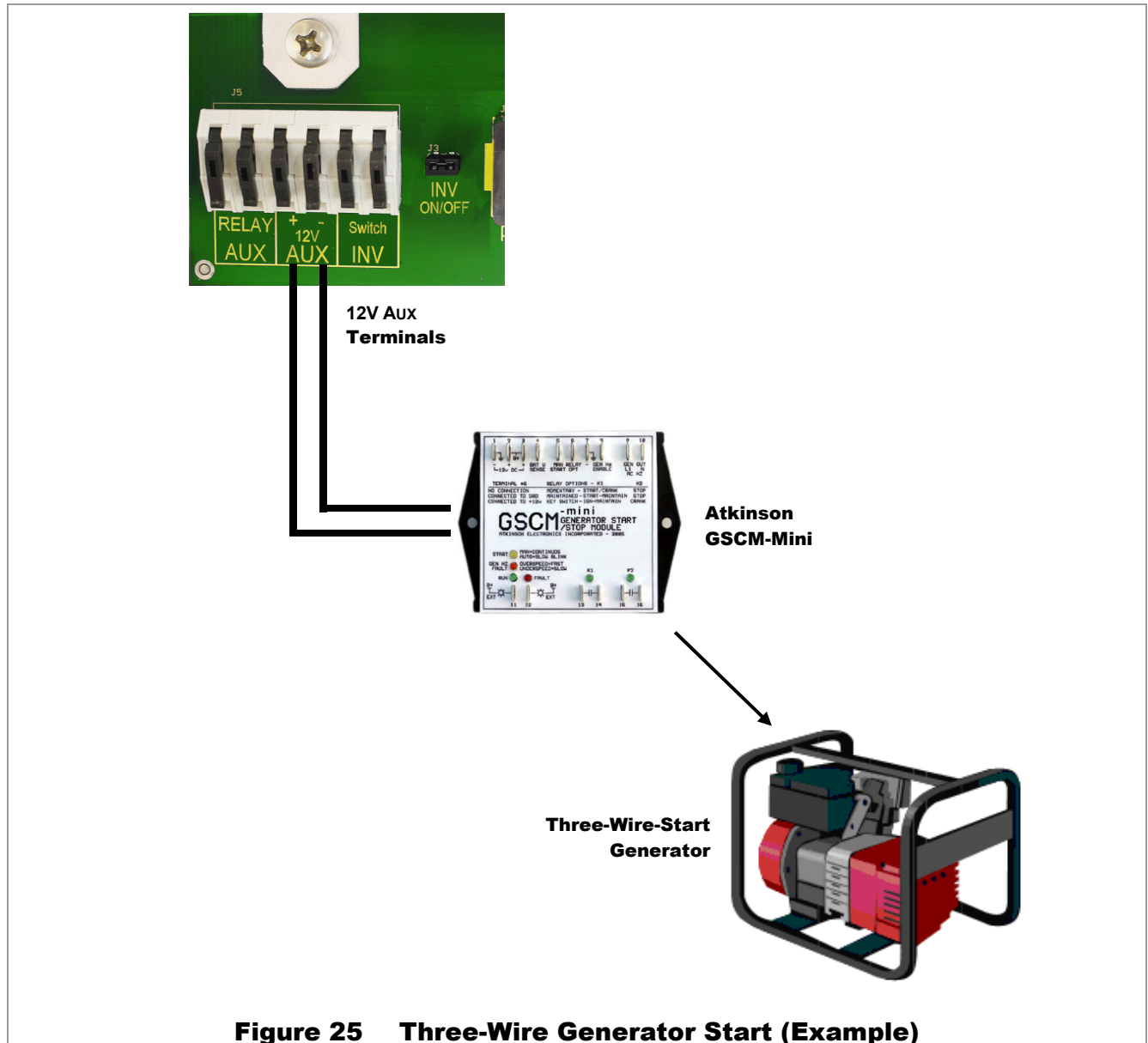

Figure 25 Three-Wire Generator Start (Example)

AC Configurations

Single-Inverter

Figure 26 (below) shows the general wiring of the Radian inverter and the AC system connected to it. This figure is not a physical representation of the inverter and does not depict the GSLC.

Figure 27 (see next page) shows the locations of AC and network connections. It is a physical diagram for wiring the GSLC, network components, and external AC devices with the inverter.

- All overcurrent devices in permanent installations must be sized for 50 Aac or less.
- All output wiring and circuit breakers must be sized appropriately for loads and inverter power.
- The inverter has wiring connections for two AC sources, but it can only accept one source at a time.

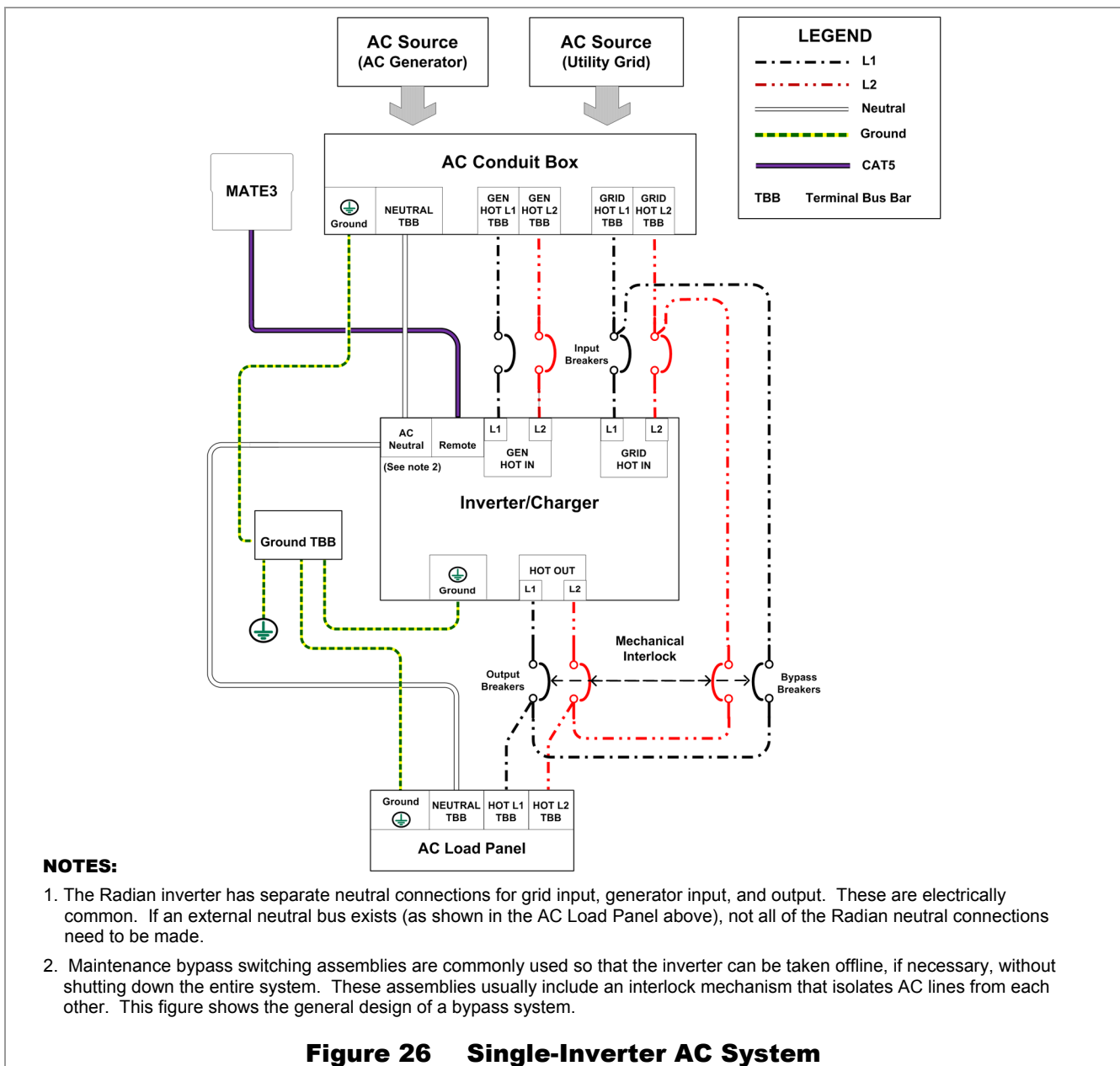

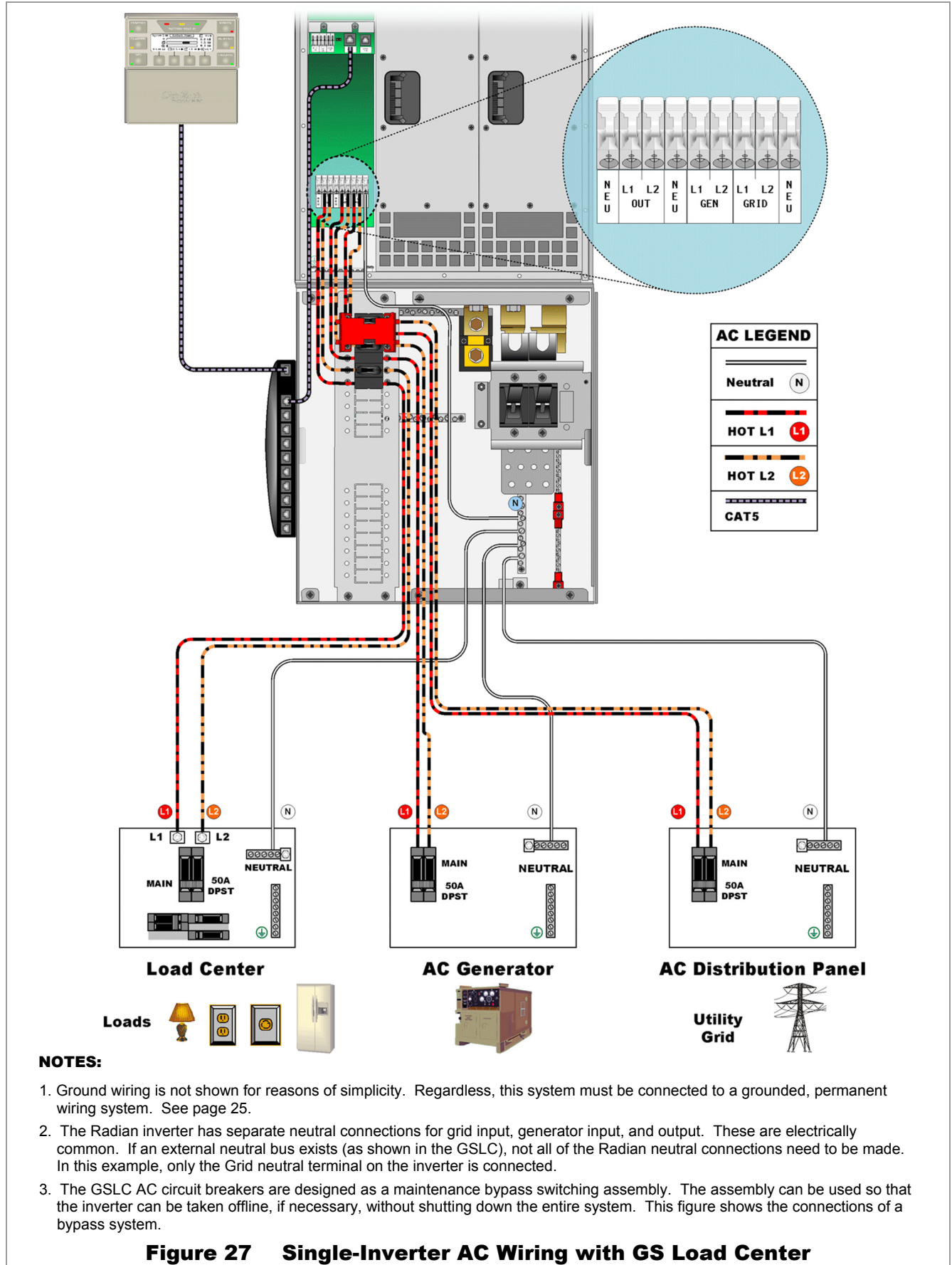

Figure 27 Single-Inverter AC Wiring with GS Load Center

Multiple-Inverter AC Installations (Stacking)

Installing multiple inverters in a single AC system supports larger loads than a single inverter can handle. This requires “stacking”. Stacking refers to how the inverters are wired within the system and then programmed to coordinate activity. Stacking allows all units to work together as a single system. The GS4048A and GS8048A models can stack up to ten units in parallel.

Stacking Connections

Stacking requires an OutBack communications manager and a system display.

- A system of four or fewer units may use the HUB4 Communications Manager.
- A system of up to ten units requires the HUB10.3 Communications Manager.
- All interconnections between the products are made using CAT5 non-crossover cable.

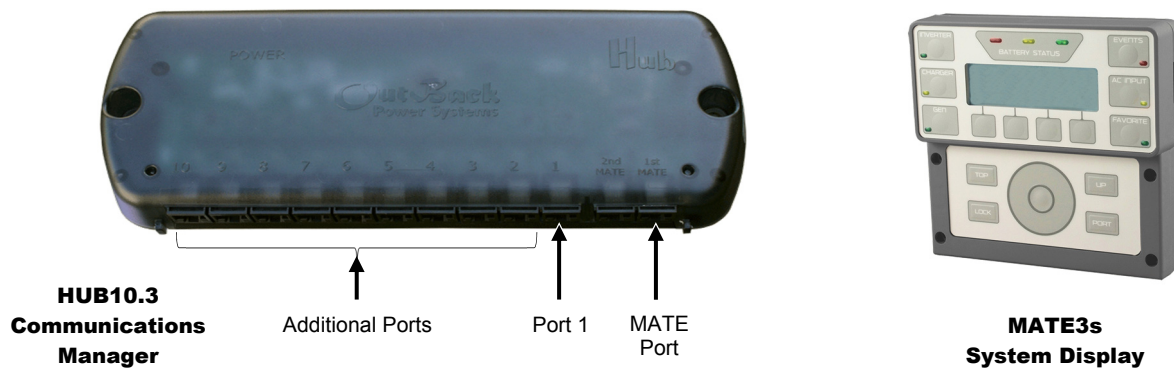



Figure 28 OutBack Communications Manager and System Display

Each inverter must be assigned a stacking mode, “master” or “slave” of some type depending on the configuration.

- The master inverter provides the primary output phase. Other inverters in the system base their phase on that of the master inverter. If the master shuts off, all other inverters also shut off. The master must sense and connect to an AC source before other inverters can connect.
 - ~ In all cases, the master inverter must be connected to port 1 on the communications manager.
 - ~ In a parallel-stacked system, the master tends to be the most heavily used unit.
- A slave inverter does not create an independent output. It simply assists the master or subphase master by adding power to the output as needed.
 - ~ Only one slave mode, “OutBack”, is available for the GS8048A and GS4048A. This mode is used for inverters stacked in parallel.
 - ~ All slave inverters are in phase with the master. The slave outputs are pulse-width-matched to be precisely synchronized with the master inverter. This avoids potential backfeed.
 - ~ OutBack slaves can be placed in Power Save mode when not in use. They are activated by the master inverter as needed. For this reason, the master is normally the only inverter to enter Search mode.

Connect all inverters other than the master to communications manager ports 2 and above.  The system display may have other port restrictions pertaining to stacking. In general, it is always important to keep track of units and ports for programming purposes.

Programming involves using the system display to assign a status and stacking value to the inverter on each port. The stacking assignments can be changed at any time as long as the master is connected to port 1.



IMPORTANT:

- ❖ The master inverter must always be connected to port 1 on the communications manager. Connecting it elsewhere, or connecting a slave to port 1, will result in backfeed or output voltage errors which will shut the system down immediately.
- ❖ All stacked Radian inverters must have the same firmware revision. If inverters are stacked with different firmware revisions, any unit with a revision different from the master will not function. The system display will display the following message:
An inverter firmware mismatch has been detected. Inverters X, Y, Z¹ are disabled. Visit www.outbackpower.com for current inverter firmware.
- ❖ Installing multiple inverters without stacking them (or stacking them incorrectly) will result in similar errors and shutdown.
- ❖ Neither the GS8048A nor the GS4048A can stack with the previous model GS8048. The GS8048 can share a HUB product with the others if it is wired independently.
- ❖ The GS8048A can be stacked with the GS4048A using HUB products. To optimize the **Power Save** function, GS4048A inverters should have higher rank numbers than any GS8048A inverter. This is true regardless of the quantity of either model. In addition, the GS4048A should not be the master inverter in a mixed system. See page 46 for additional discussion of **Power Save**.
- ❖ Although stacking allows greater capacity, the loads, wiring, and overcurrent devices must still be sized appropriately. Overloading may cause circuit breakers to open or the inverters to shut down.
- ❖ An AC source should provide input to all inverters on all phases.

¹ The port designations for the mismatched inverters are listed here.

Stacking Configurations

Parallel Stacking (Dual-Stack and Larger)

In parallel stacking, two or more inverters are stacked to create a single, common AC bus as shown in Figure 29.

- All inverters share a common input (AC source) on both L1 and L2. They run loads on common L1 and L2 output buses. The master inverter provides the primary output. The slaves are connected to the same L1 and L2 outputs and assist the master.
- The slave outputs are controlled directly by the master and cannot operate independently.
- Slave inverters can go into Silent mode when not in use. The master inverter will activate individual slave inverters based on load demand. This reduces idle power consumption and improves system efficiency.
- Up to ten inverters may be installed in a parallel arrangement. The example on this page shows three inverters. The wiring diagrams on the next few pages show two.

Figure 30 (see page 44) shows the general wiring of the inverters and the AC system connected to them. This figure is not a physical representation of the inverters and does not depict the GSLC.

Figure 31 (see page 45) shows the locations of AC and network connections. This is a physical diagram for wiring the GSLC, network components, and external AC devices with each inverter.

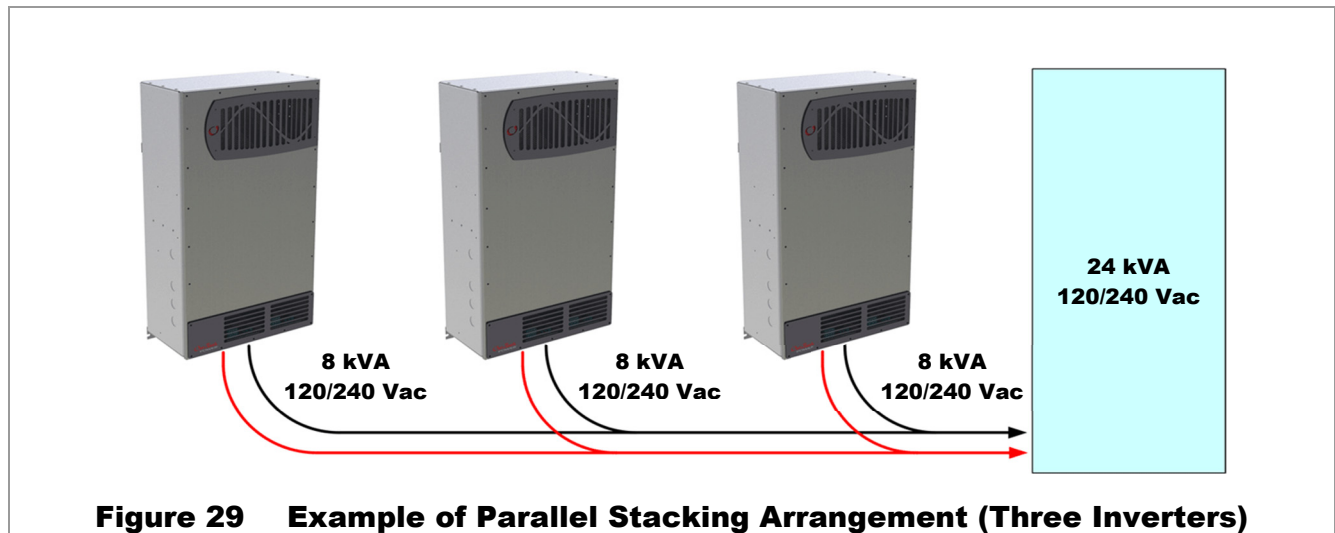

When installing a parallel system, the following rules must be observed.

- Parallel stacking requires the system display and the communications manager. See the HUB10.3 literature for any required jumper configurations.
- One inverter, and one inverter only, is always the master and is programmed as **Master**.  This is the default setting.
- The master must be connected to port 1 of the communications manager. Other inverters must not be assigned as master.
- All slave inverters, regardless of number, should be assigned as **Slave** during programming. Slaves can be connected to any port numbered 2 and above.
- All wiring and circuit breakers must be sized appropriately for loads and inverter power.
- The AC input (generator or utility grid) must be a split-phase source of the proper voltage and frequency.
- The input/output bypass kit for the GS Load Center cannot be used. See page 14 for more information.

Installation

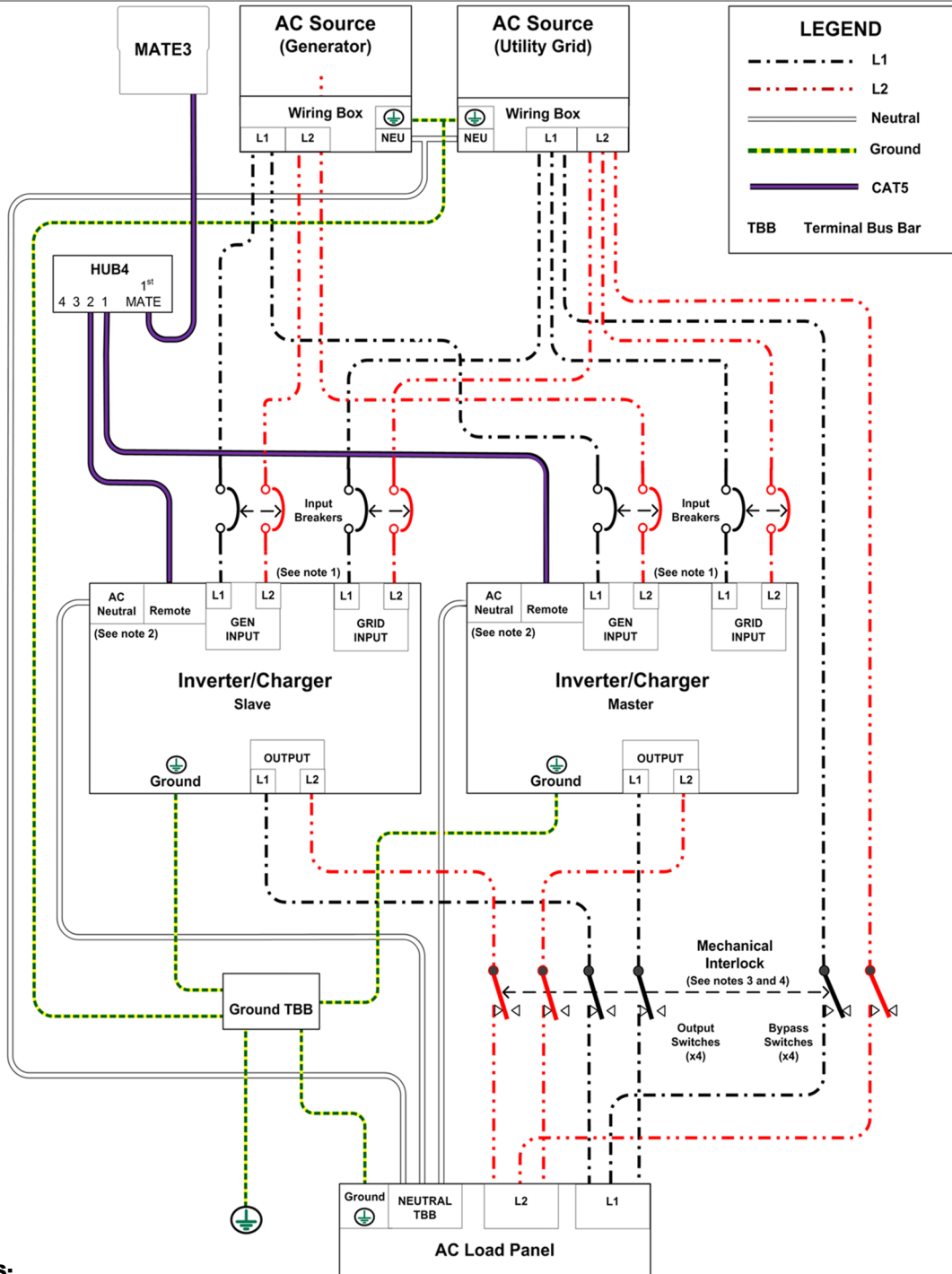

NOTES:

1. The Radian inverter has separate neutral connections for grid input, generator input, and output. These are electrically common. If an external neutral bus exists (as shown in the AC Load Panel above), not all of the Radian neutral connections need to be made.
2. Maintenance bypass switching assemblies are commonly used so that the inverter can be taken offline, if necessary, without shutting down the entire system. These assemblies usually include an interlock mechanism that isolates AC lines from each other. This figure shows the general design of a bypass system.
3. When multiple inverters are stacked, the GS Load Center (GSLC) for each inverter can be wired together to serve as a common input conduit box and AC load center. However, the GSLC bypass switching assemblies are only sized for single inverters and cannot work in conjunction with each other. The GSLC bypass assemblies should not be used with multiple inverters present. (See page 15.) An external bypass assembly must be used instead. Larger external assemblies are available from other manufacturers.

Figure 30 Parallel Wiring

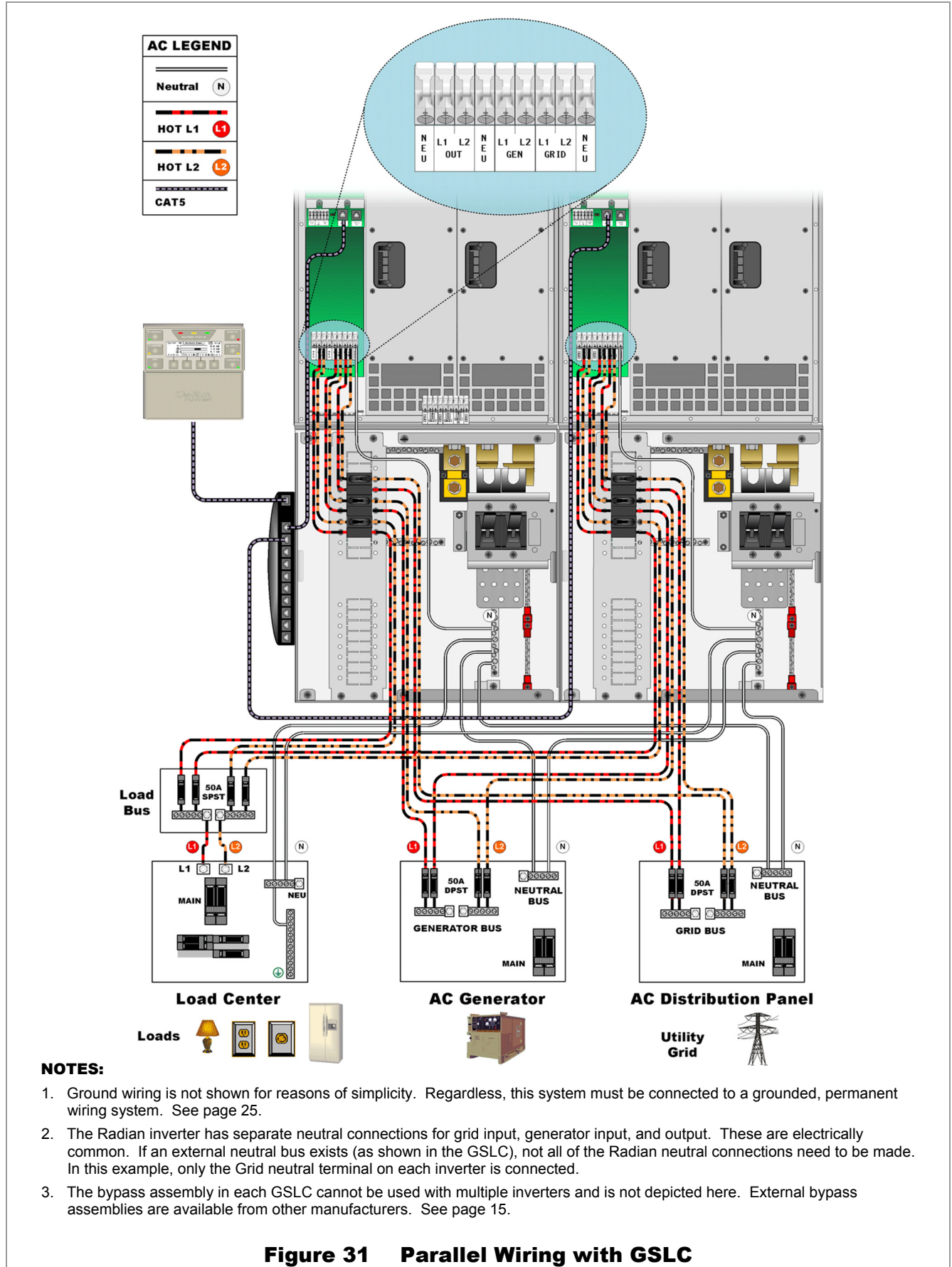

Figure 31 Parallel Wiring with GSLC

Power Save



IMPORTANT:

- ❖ In a parallel-inverter system, **Power Save** must be programmed before commissioning. Leaving the inverters at the factory default settings (or setting them incorrectly) will cause erratic system performance. See the *Radian Series Inverter/Charger Operator's Manual* for a table of menu items and settings. See the system display literature for navigation instructions.
- ❖ Stacked GS4048A inverters should **not** be set to use **Power Save**. All inverters should be set as active. See **Forcing All Slaves To Be Active** on page 48.
- ❖ **Power Save** may be used when stacking a combination of GS4048A and GS8048A inverters. See page 41.

Each inverter consumes approximately 30 watts of idle power while it remains on, even if it is not actively inverting or charging. The **Power Save** function allows the option to put part of a parallel GS8048A system into a “sleep” state known as Silent mode. This mode minimizes the idle consumption. The inverters will come on again when the loads require power. (The term “Silent” is also used in an unrelated context during battery charging.)

- Every time the load increases by approximately 2.5 kW, the master inverter activates one or more additional modules for assistance. When the loads decrease to lesser wattages (as detected by the master), the modules deactivate one at a time and return to Silent mode.
- The first module in the master does not enter Silent mode. It remains active unless specifically turned off.
- The order in which additional modules activate (or return to Silent mode) is controlled by programming in the system display. The inverters are given a “rank”, or level number. Lower rank numbers activate when lesser loads are applied. Higher ranks only activate when the load increases to a high level.



The actual watt and ampere thresholds for activating Radian inverters are depicted on the following pages.



IMPORTANT:

It is highly recommended to use the Profile Wizard in a MATE3-class system display to set up this function. It is essential to set the slave Power Save Levels in sequential order so that they turn on and off correctly. The Profile Wizard automatically programs the correct priorities. (See the *Radian Series Inverter/Charger Operator's Manual* for a table of menu items and settings. See the system display literature for navigation instructions.)

To set these items manually without the Profile Wizard:

In the system display, the **Power Save Ranking** screen uses **Power Save Level** selections to assign inverter ranks. The screen reads **Master Power Save Level** or **Slave Power Save Level**, depending on the inverter's stacking designation. 

- **Master Power Save Level** appears on an inverter which is set as master (the default setting). When stacking, this selection should only appear on the inverter using Port 1 of the communications manager. The range of rank numbers is 0 to 31. The default value is 0. The master is normally left at this value.
- **Slave Power Save Level** appears on an inverter which is set as slave. The range of rank numbers is 1 to 31. (The default value for all ports is 1.)
- The ranks are prioritized so that lower-numbered ranks turn on sooner and higher ranks turn on later. The lowest-ranked unit will not go silent and will remain on unless ordered otherwise. The lowest-ranked unit is expected to be the master. The priorities are the same across both screens; thus, if P01 (master) is set at 0 and P02 (slave) is set at 1, the slave will turn on later. Since the **Master** item is the only one that goes to 0, it is easy to ensure that all other units besides the master go silent.

The GS8048A has two modules. The modules are controlled individually. The Power Save function will activate one module at a time, making an additional 4 kW of power available for every load increase of approximately 2.5 kW.

Figure 33 shows a system of four GS8048A inverters (the master and three slaves) in a parallel system with a common load bus. The labels at the top indicate the ranking of each unit. The notations at the bottom show how the units are activated in sequence as loads of approximately 2.5 kW are applied.

- The first line shows little load and only the first module in Master is activated.
- The second line shows load beginning to be applied. The second module in Master is activated.
- The third line shows increasing load. The first module in Slave 1 is activated.
- The fourth line shows even higher load. Slave 1 is completely activated.

In general, roughly 5 kW of loads are applied to fully activate an additional slave inverter.

- In the example shown in Figure 33, an 8-kW load has been applied, fully activating the first slave.
- In this example, loads of approximately 17 to 18 kW would be needed to turn on all inverters.

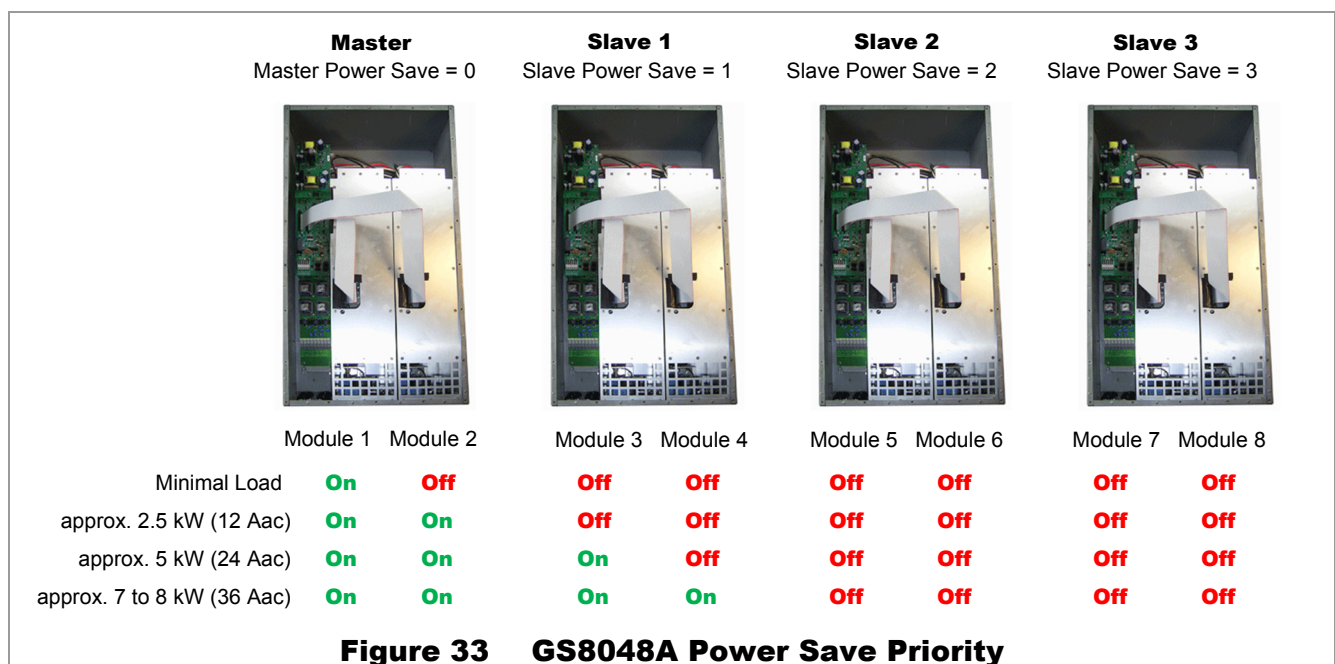

Installation

	<p>IMPORTANT:</p> <p>Set the master rank at 0 and arrange the slave ranks in order (1, 2, 3, 4, etc.). Another order may defeat the purpose of Power Save mode. Leaving the master at 0 makes 4 kW of power available from the master; the other inverters should not be active. If a slave is ranked lower (prioritized higher) than the master, that slave will not go silent.</p> <p>NOTE: Disregard this rule if the installation requires some of the slaves to be continuously active.</p>
	<p>IMPORTANT:</p> <p>Do not give slave inverters the same rank numbers. If, for example, multiple slaves were all ranked at 1, they would all come on at the same time. Once they came on, the divided load would cause the master to detect a minimal load on its output, so it would shut off all the slaves, at which point the master would read a high load again. This could quickly escalate into a rapid on/off cycling of inverters and could cause long-term system problems.</p>
	<p>NOTE:</p> <p>Power Save is used by the battery chargers of stacked systems with slave inverters. Not all chargers are activated immediately. Initially the master inverter is the only active charger. The batteries will absorb current up to the maximum for all chargers. When the batteries (and the master) draw more than 12 Aac, the master will turn on the first slave charger. The batteries will absorb that additional current and more. The master will then turn on more slaves until all active chargers are operating.</p> <p>If the master Charger AC Limit is turned to 11 or less, it will not turn on any slaves and will remain the only charger. For more information on charging with stacked inverters, see the <i>Radian Series Inverter/Charger Operator's Manual</i>.</p>

Forcing Specific Slaves to be Active:

It is possible to raise the priority of a slave and force it to activate. This is done by ranking the master higher than that slave. However, the **Master Power Save Level** scale is not the same as the **Slave** level. **Slave** settings apply to the whole inverter. **Master** settings apply to each module.

This means that increasing the master by one rank will only turn on one additional module. To completely turn on a slave, the master must be increased two ranks.

In Table 5, instead of loads, the number on the far left of each line shows the master increased by one rank. (This example is otherwise the same as Figure 33.) The last line of the table shows the master increased to 3, which is the same as the rank of the highest slave. However, this only activates the first of the slaves. The master would need to be set to rank 7 to activate all slaves.

Table 5 Changing Master Power Save Levels (GS8048A)

Master			Slave 1			Slave 2			Slave 3		
Power Save	Module 1	Module 2	Power Save	Module 3	Module 4	Power Save	Module 5	Module 6	Power Save	Module 7	Module 8
0	On	Off	1	Off	Off	2	Off	Off	3	Off	Off
1	On	On	1	Off	Off	2	Off	Off	3	Off	Off
2	On	On	1	On	Off	2	Off	Off	3	Off	Off
3	On	On	1	On	On	2	Off	Off	3	Off	Off

Forcing All Slaves to be Active:

All slave inverters can be made active to defeat the Power Save function. This is strongly recommended when stacking GS4048A inverters.

To force all slaves to be active, set **Master Power Save Level** to twice the number of slave inverters in the system. For example, if there is one master and one slave, **Master Power Save Level** should be set to 2. If two slaves are present, **Master Power Save Level** should be set to 4.

NOTE: Make certain the **Slave Power Save Level** settings remain lower than this number. The default setting is 1.



Commissioning

Functional Test



WARNING: Shock Hazard and Equipment Damage

The inverter cover must be removed to perform these tests. The components are close together and carry hazardous voltages. Use appropriate care to avoid the risk of electric shock or equipment damage.

It is highly recommended that all *applicable* steps be performed in the following order. However, if steps are inapplicable, they can be omitted.

- If the results of any step do not match the description, see the *Operator's Manual* for troubleshooting.

Pre-startup Procedures

1. Ensure all DC and AC overcurrent devices are opened, disconnected, or turned off.
2. Double-check all wiring connections.
3. Confirm that the total load does not exceed the inverter's rated power.
4. Inspect the work area to ensure tools or debris have not been left inside.
5. Using an accurate digital voltmeter (DVM), verify battery voltage. Confirm the voltage is correct for the inverter model. Confirm the polarity.
6. Connect the system display, if present.



CAUTION: Equipment Damage

Incorrect battery polarity will damage the inverter. Excessive battery voltage also may damage the inverter. This damage is not covered by the warranty.



CAUTION: Equipment Damage

Use of a three-phase AC source may damage the inverter. This damage is not covered by the warranty.



IMPORTANT:

Prior to programming (see **Startup**), verify the operating frequency of the AC source. This is necessary for correct AC operation. The default setting is 60 Hz, but this can be changed to 50 Hz.

Startup

To start a single-inverter system:

1. Close the main DC circuit breakers (or connect the fuses) from the battery bank to the inverter. Confirm that the system display is operational, if present. 
2. If a system display is present, perform all programming for all functions. These functions may include AC input modes, AC output voltage, input current limits, battery charging, generator starting, and others.

Commissioning

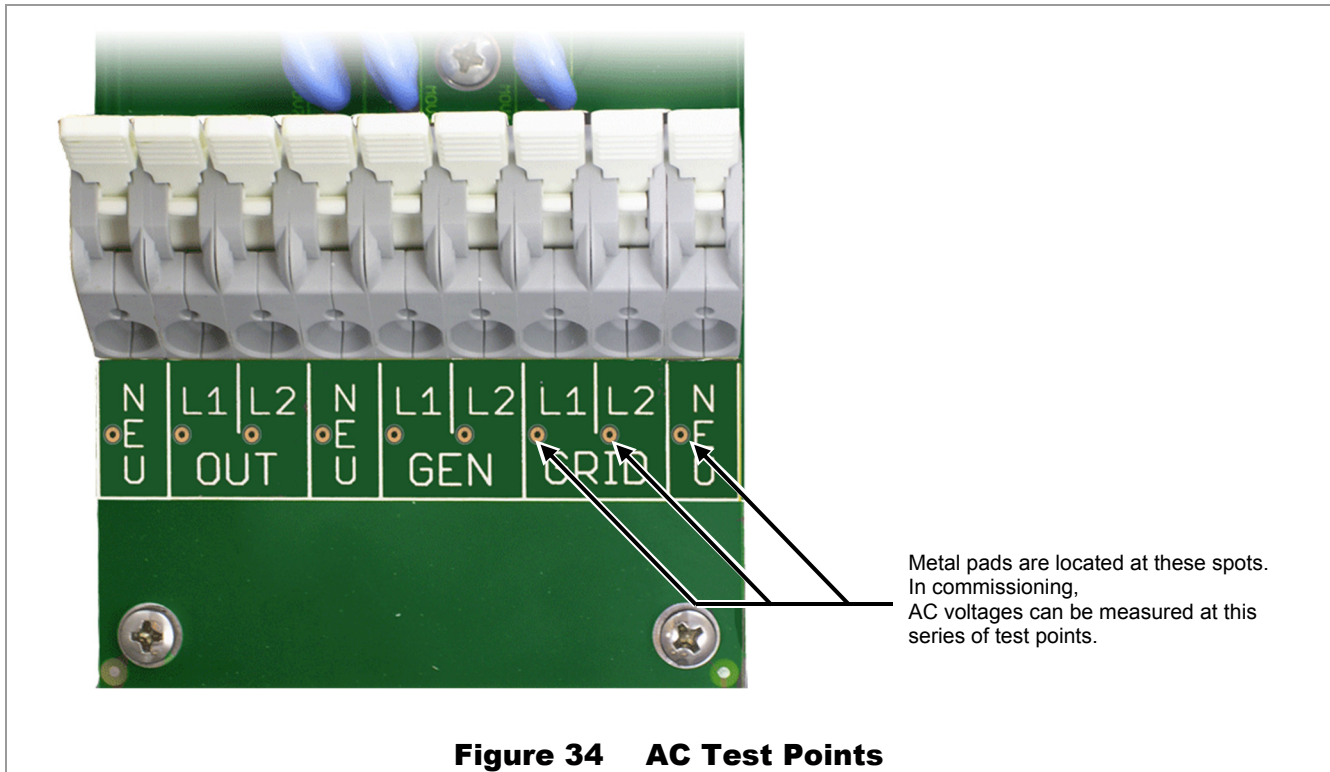

3. Turn on the inverter using the system display (or external switch, if one has been installed). The Radian's default condition is Off. Do not turn on any AC circuit breakers at this time.
4. Using a DVM, verify 120 Vac (or appropriate voltage) between the **L1** and **N OUT** terminals, and between the **L2** and **N OUT** terminals. (See Figure 34 for AC test points.) The inverter is working correctly if the AC output reads within 10% of 120 Vac or the programmed output voltage.
5. Proceed past the items below to Step 6 on the next page.

To start a multiple-inverter (stacked) system:

1. Close the main DC circuit breakers (or connect the fuses) from the battery bank to the inverters. Repeat for every inverter present. Confirm that the system display is operational.

With the system display, perform any programming for stacking and all other functions.  (See pages 40 and 46.) These functions may also include AC input modes, AC output voltage, input current limits, battery charging, generator starting, and others. When stacking in parallel, all slave inverters will observe the programming settings of the master inverter. They do not need to be programmed individually. In a MATE3-class system display, the Profile Wizard may be used to assist programming.

2. Turn on the master inverter using the system display (or external switch, if one was installed). The Radian's default condition is Off. Do not turn on any AC circuit breakers at this time.
3. Using the system display, temporarily bring each slave out of Silent mode by raising the Power Save Level of the master. (See page 48.)
 - As each slave is activated, it will click and create an audible hum.
 - Confirm that the system display shows no fault messages. Confirm that the output voltages are still correct. Individual inverter voltage readings are not necessary since all inverters are in parallel.

- Using a DVM, verify 120 Vac (or appropriate voltage) between the master inverter's **L1** and **N OUT** terminals, and between the **L2** and **N OUT** terminals. The inverter is working correctly if the output reads within 10% of 120 Vac or the programmed output voltage. If necessary, confirm appropriate voltages from one unit to the next.
- When this test is finished, return the master to its previous settings.

After output testing is completed, perform the following steps:

- Close the AC output circuit breakers. If AC bypass switches are present, place them in the normal (non-bypass) position. *Do not connect an AC input source or close any AC input circuits.*
- Use a high-resolution voltmeter to verify correct voltage at the AC load panel.
- Connect a small AC load and test for proper functionality.
- Close the AC input circuit breakers and connect an AC source.
 - Using a high-resolution voltmeter on the correct input, check all **L1**, **L2**, and **N** input terminals for 120 Vac and 240 Vac (or appropriate voltage) from the AC source.
 - If a system display is present, confirm that the inverter accepts the AC source as appropriate for its programming. (Some modes or functions may restrict connection with the source. If one of these selections has been used for the system, it may not connect.) Check the system display indicators for correct performance.
- If the charger is activated, the inverter will perform a battery charging cycle after powering up. This can take several hours. If restarted after a temporary shutdown, the inverter may skip most or all of the charging cycle. With the system display, confirm that it is charging as appropriate.
- Test other functions which have been enabled, such as generator start or search mode.
- Compare the voltmeter's readings with the system display meter readings. If necessary, the system display's readings can be calibrated to match the voltmeter more accurately. Calibrated settings include AC input voltage for the **GRID** and **GEN** inputs, AC output voltage, and battery voltage.

Powering Down

If steps are inapplicable, they can be omitted. However, it is recommended that all *applicable* steps be performed in the following order. These steps will completely isolate the inverter.

To remove power from the system:

- Turn off all load circuits and AC input sources.
- Turn off all renewable energy circuits.
- Turn each inverter OFF using the system display or external switch.
- Turn off the main DC overcurrent devices for each inverter.

Adding New Devices

When adding new devices to the system, first turn off the system according to the preceding instructions. After adding new devices, perform another functional test, including programming.

Operation

Once the mounting, wiring, and other installation steps are completed, proceed to the *Radian Series Inverter/Charger Operator's Manual*.

Refer to the system display literature for programming instructions and menus.

Firmware Updates



IMPORTANT:

All inverters will shut down during firmware updates. If loads need to be run while updating the firmware, bypass the inverter with a maintenance bypass switch. Communication cables must remain connected and DC power must remain on. Interrupted communication will cause the update to fail and the inverter(s) may not work afterward. Inverters automatically update one at a time beginning with Port 1. Each requires about 5 minutes.

Updates to the Radian's internal programming are periodically available at the OutBack website www.outbackpower.com. If multiple inverters are used in a system, all units must be upgraded at the same time. All units must be upgraded to the same firmware revision. 



IMPORTANT:

All stacked Radian inverters must have the same firmware revision. If multiple stacked inverters are used with different firmware revisions, any inverter with a revision different from the master will not function. (See the stacking section on page 35.) The system display will show the following message:

An inverter firmware mismatch has been detected. Inverters X, Y, Z ² are disabled. Visit www.outbackpower.com for current inverter firmware.

See the system display *Overview Guide* for instructions on performing updates.



NOTE:

The MATE3s system display must be used when upgrading the inverter to firmware revision 001.006.063 or higher.

² The port designations for the mismatched inverters are listed here.

.GIP File Installation for Grid Support

To enable Grid support functionality in different parts of the world, it may be necessary to update the inverter firmware. The .ZIP files for update can be downloaded from the **Radian Grid Support** section of the **Firmware Update** page at **www.outbackpower.com**. Each .GIP file available with an update contains a “package” of grid support settings associated with different utility companies or regional standards.

	<p>IMPORTANT:</p> <ul style="list-style-type: none"> ❖ The MATE3s system display is required for this process. ❖ Make certain to extract (unzip) all the files before loading all of the contents onto the MATE3s. If the files are loaded to the card in compressed form, they will be unusable. ❖ These contents contain a Readme text file which is necessary to the instructions below.
---	---

To install Grid Support .GIP Files:

1. Perform a firmware update as noted above.

NOTES:

- The MATE3s should be revision 1.001.000 or higher for grid support functionality.
 - For grid-interactive parameters, the Installer Password is required and may need to be changed from the default setting of **1732**. See the *MATE3s Programming Guide* for more information.
2. From the MATE3s **Main Menu** (**A** in Figure 35), choose **Firmware Update** (**B**) and then **GS Inverter** (**C**). The display will show that new firmware is present. (The revision should be 001.006.063 or higher.) Press **Update** (**D**) to download this firmware into the Radian inverter. This can take up to ten minutes per inverter. In certain systems it may take up to 20 minutes.

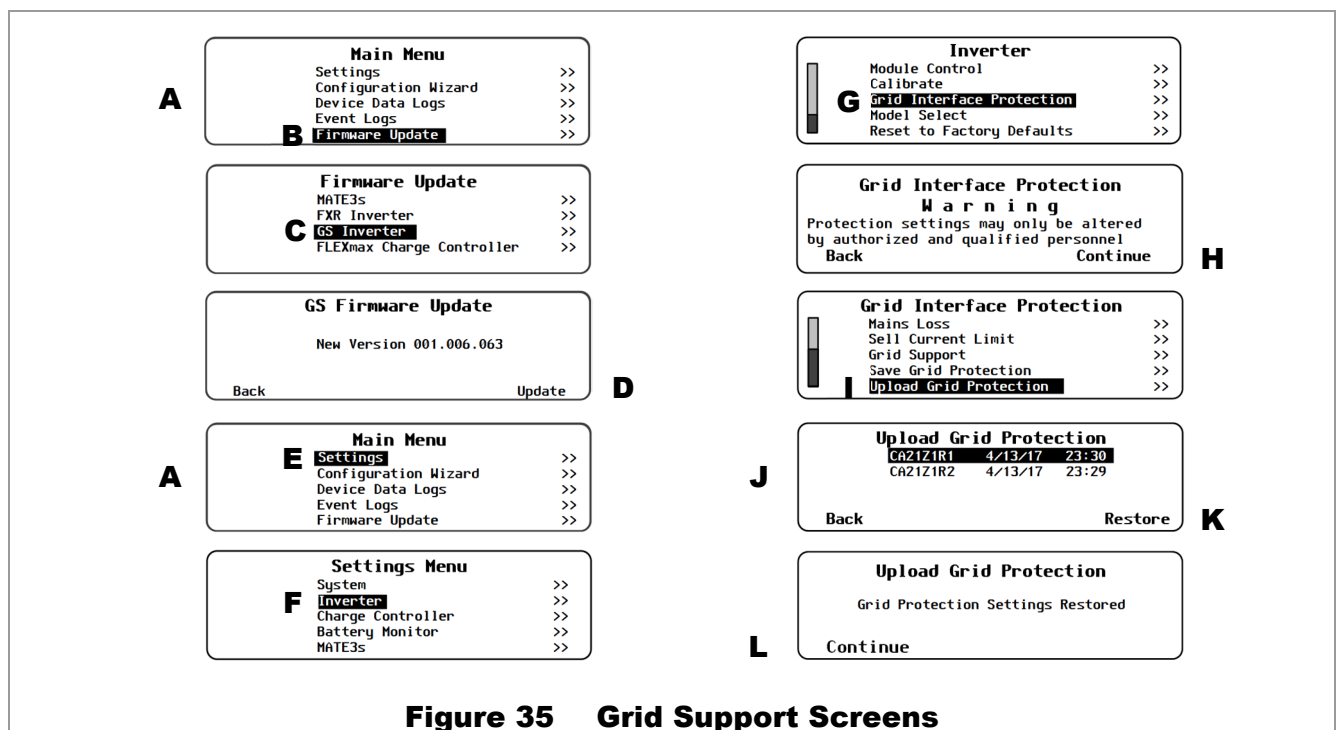

Figure 35 Grid Support Screens

Commissioning

3. Press the **<Back>** soft key and then the **UP** key to return to the **Main Menu A**. Select **Settings (E)** followed by **Inverter (F)**. Scroll to **Grid Interface Protection (G)** and press the MATE3s center button. Press **Continue (H)** to enter the menu for protected settings.
4. Scroll to **Upload Grid Protection (I)** and select it with the center button. There are different files for different regions. Options for Hawai'i, Australia, and other locations are available.
5. In the Upload Grid Protection screen (J), scroll to the .GIP file that is required by the utility. See the spreadsheet file and ReadMe text file (in the download folder) to identify the correct .GIP file to be loaded and the values included in each .GIP file.
6. Press the **<Restore>** soft key (**K**) to install the selected settings.
7. A confirmation screen will appear. Press **Continue (L)** to exit to the **Main Menu A**.

The update and settings are now complete.

Preventative Maintenance

The Radian inverter requires almost no regular maintenance. However, OutBack recommends the following items on a periodic basis:

- Check all electrical connections periodically for tightness using the torque values from pages 25 through 29.
- Check the fan screens on each module and clear them of any debris.
- Check the batteries according to the recommendations and schedule provided by the battery manufacturer. Perform equalization as appropriate. 

Definitions

Table 6 Terms and Definitions

Term	Definition
12V AUX	Auxiliary connection that supplies 12 Vdc to control external devices.
AIC	Ampere Interrupting Capacity; the rated current a circuit breaker can interrupt without damage
AGS	Advanced Generator Start
Communications manager	Multi-port device such as the OutBack HUB10.3, used for connecting multiple OutBack devices on a single remote display; essential for stacking inverters
CSA	Canadian Standards Association; establishes Canadian national standards and the Canadian Electrical Code, including C22.1 and C22.2
ETL	Electrical Testing Laboratories; short for the company ETL Semko (Intertek); refers to a certification issued by ETL to OutBack products indicating that they meet certain UL standards
GFDI	Ground Fault Detector Interruptor; a safety device for PV systems
GND	Ground; a permanent conductive connection to earth for safety reasons; also known as Chassis Ground, Protective Earth, PE, Grounding Electrode Conductor, and GEC
Grid-interactive, grid-intertie, grid-tie	Utility grid power is available for use and the inverter is a model capable of returning (selling) electricity back to the utility grid
GSLC	GS Load Center; the wiring box for the Radian (GS) inverter
IEC	International Electrotechnical Commission; an international standards organization
Invert, inverting	The act of converting DC voltage to AC voltage for load use or other applications
Master	An inverter which provides the primary output phase of a stacked system; other stacked inverters base their output and on/off state on the master
NEU	AC Neutral; also known as Common
Neutral-to-ground bond	A mechanical connection between the AC neutral (Common) bus and the ground (PE) bus; this bond makes the AC neutral safe to handle
Off-grid	Utility grid power is not available for use
PV	Photovoltaic
RE	Renewable Energy
RELAY AUX	Auxiliary connection that uses switch (relay) contacts to control external devices.
RTS	Remote Temperature Sensor; accessory that measures battery temperature for charging
Slave	An inverter which adds additional power to the master in a stacked system; a slave does not provide an output of its own
Split-phase	A type of utility electrical system with two “hot” lines 180° out of phase, common in North America; each line typically carries 120 Vac (or the nominal line voltage) with respect to neutral and 240 Vac with respect to each other
System display	Remote interface device (such as the MATE3s), used for monitoring, programming and communicating with the inverter; also called “remote system display”
Three-phase, 3-phase	A type of utility electrical system with three “hot” lines, each 120° out of phase; each carries the nominal line voltage with respect to neutral; each carries voltage with respect to each other equaling the line voltage multiplied by 1.732
UL	Underwriters Laboratories; refers to a set of safety standards governing electrical products
Utility grid	The electrical service and infrastructure supported by the electrical or utility company; also called “mains”, “utility service”, or “grid”



Index

A

AC Inputs.....	9, 24, 29, 31
AC Terminals	29
AC Test Points	50
AC Wiring	24, 29
Adding New Devices	51
Advanced Generator Start (AGS)	33, 35
Applications	9
AUX	23, 33
AXS Port.....	6

B

Battery Bank.....	11
Sizing	12
Bypass.....	14

C

Caution Symbol.....	5
Charging Current.....	48
Clearance	17
Commissioning.....	49
Communication Cables	33, 40
Communications Manager	
Connections	33, 40
Components	7
Conductor Size	
AC Conductors.....	29
DC Conductors	27
Ground Conductors	25
Cover.....	22
CSA	6

D

DC Terminals	23, 27, 28
DC Wiring	26, 27
Definitions.....	55
Dimensions	
Inverter.....	17
System	18
Diversion Control.....	33, 34

Drawings

Generator Control.....	36, 37
Multiple AC Sources.....	31
Parallel-Stacked System	43, 44, 45
Single-Inverter System.....	38
Transfer Relay.....	31
DVM.....	19, 49, 50, 51

E

Environmental Requirements	17
----------------------------------	----

F

Features.....	6
Firmware.....	7, 52, 53
FLEXmax.....	7, 21
FLEXmax 100.....	21
Front Cover.....	22
Functional Test.....	49

G

Gen Alert.....	35
Generator.....	38, 43
Applications	9, 31
Automatic Control.....	33
Requirements.....	14
Three-Wire	37
Two-Wire.....	35, 36
Control.....	35
Sizing.....	14
Type	14
Wiring	29
GFCI	29
GFDI	25
GIP File.....	52, 53
Grid Support	9, 10, 52, 53
Grid-Interactive	55
Grounding	24, 25
GSLC	7, 14, 18, 21, 29, 45, 55

H

HUB 7, 21, 40

I

IEC 25, 55
 Important Symbol 5
 Ingress Protection (IP) 17
 Input Modes 10

J

Jumper J3 23, 32

L

Listings 6
 Location 17

M

Maintenance Bypass 14
 Maintenance Checks 54
 Master (Stacking) 40, 43
 MATE and MATE2 7
 MATE3s, MATE3-class 6, 7, 21, 24, 46, 53
 AUX 33
 Stacking 40
 Modes 10
 Modules 46
 Mounting
 Components 21
 Dimensions 17, 18
 Orientation 17
 Plate 19, 20
 Multiple AC Sources 31

N

Neutral-Ground Bonding 14, 25, 29
 Note Symbol 5

O

On and Off 32
 OPTICS RE 6

P

Parallel Stacking 43, 44
 Ports, RJ45 and RJ11 24, 33
 Power Save 41, 46
 Powering Down 51

PV 9, 11

R

Ranks, Power Save 41, 46
 Relative Humidity (RH) 17
 Remote System Display 55
 Remote Temperature Sensor (RTS) 7, 24, 33
 Renewable Energy 11
 Revision 7, 52, 53
 Ribbon Cables 23

S

Silent
 Power Save 46
 Sizing 38
 Slave (Stacking) 40, 43
 Stacking 40, 52
 Commissioning 50
 Parallel 43, 44
 Power Save 48
 Startup 49
 Switch 23, 32
 Symbols Used 5
 System Display 7, 52, 55
 Connections 33
 Programming 14, 33, 35
 Stacking 43

T

Temperatures 17
 Terms and Definitions 55
 Test 49
 Test Points 50
 Tools Required 19
 Torque Requirements
 DC Terminals 27
 Ground Terminals 25
 Transfer Relay 31

U

UL 1741 6
 Updating Firmware 52
 Utility Grid 38, 43, 55
 Applications 9, 31
 Wiring 29

V

Vent Fan 34

W

Warning Symbol	5	AUX Connections	33
Website	52	DC Connections	26
Wiring		Ground Connections	24, 25
AC Connections	24, 29	Parallel Inverters	43, 45
		Single Inverter	38
		Stacking	
		Parallel	44



Masters of the Off-Grid.™ First Choice for the New Grid.

Corporate Headquarters
17825 – 59th Avenue N.E.
Suite B
Arlington, WA 98223 USA

European Office
Hansastraße 8
D-91126
Schwabach, Germany